

Director Sign User Manual

The most recent update of this manual can be found at Adaptive's Web site: <http://www.adaptivedisplays.com>

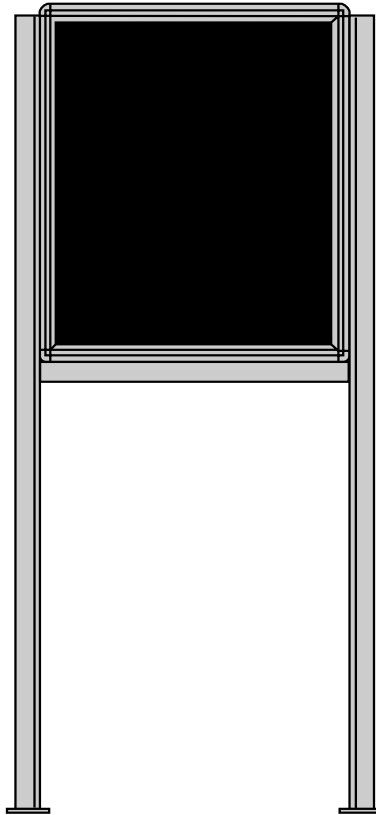

Manual part number: 9702-2005B

Revision date: 10/27/03

© Copyright 2003 Adaptive Micro Systems, LLC. All rights reserved.

Adaptive Micro Systems • 7840 North 86th Street • Milwaukee, WI 53224 USA • 414-357-2020 • 414-357-2029 (fax) • <http://www.adaptivedisplays.com>

Trademarked names appear throughout this document. Rather than list the names and entities that own the trademarks or insert a trademark symbol with each mention of the trademarked name, the publisher states that it is using names for editorial purposes and to the benefit of the trademark owner with no intention of improperly using the trademark.

The following are trademarks of Adaptive Micro Systems: ActiveX, Adaptive, Alpha, AlphaLert, AlphaNET, AlphaNet plus, AlphaEclipse, AlphaPremiere, AlphaTicker, AlphaVision, AlphaVision InfoTracker, Automode, BetaBrite, BetaBrite Director, BetaBrite Messaging Software, Big Dot, Director, EZ KEY II, EZ95, PagerNET, PPD, PrintPak, Serial Clock, Smart Alec, Solar, TimeNet.

The distinctive trade dress of this product is a trademark claimed by Adaptive Micro Systems, LLC.

Due to continuing product innovation, specifications in this manual are subject to change without notice.

Contents

1	Introduction	6
	Purpose	6
	Revision history	6
	Related documentation	6
	Controlling electrostatic discharge (ESD)	7
	Safety information	7
	Equipment symbols	7
	Warnings and cautions	8
2	Equipment overview	9
	Technical specifications	10
	Wood case	10
	Aluminum case	10
	EMI compliance	10
3	Sign installation and setup	11
	Mounting the wood Director	12
	Wall mounting	12
	Stand mounting (without brochure rack)	13
	Stand mounting (with brochure rack)	16
	Mounting the aluminum Director	20
	Wall mounting	20
	Stand mounting	21
	Connecting signs to a computer	23
	One sign to one computer	23
	Multiple signs to a network	24
4	Software installation and setup	25
	Installing the software	26
	Setting up the software	27
5	Using the remote control	28
	Overview	28
	Turning a sign on and off	29
	Setting a sign's time and date	30
	Clearing a sign's memory	32
	Setting a sign's password	33
	How to set a sign's password	33
	Forgetting a sign's password	34
	Deleting a sign's password	34
	Using the remote control's sound control	35
	Setting a sign's serial address	35

6	Beginning text messaging	36
	Example 1—Using upper and lower text	36
	Example 2—Displaying messages in PAGE number order (A, B, C).....	40
	Example 3—Displaying messages in time order	42
	Example 4—Changing the text of an existing message	44
	Example 5—Deleting messages	46
7	Advanced text messaging	47
	Example 6—Displaying the time and date	47
	Example 7—Using the FLASH mode to highlight information	51
	Example 8—Using fonts and colors	53
	Example 9—International characters.....	56
8	Appendices	57
	Appendix A—Quick Reference Card	57
	Appendix B—Sign diagnostic test	58
	Appendix C—Transferring a sign’s memory from one sign to another.....	59
	Appendix D—Using the IR Message Loader.....	60
	Appendix E—Updating the firmware (wood Director)	62
	Appendix F—DIP switch access (aluminum Director)	63
	Appendix G—DIP switch settings (aluminum Director)	64
	Appendix H—RS232 in and echo out (aluminum Director)	65

Warranty

Adaptive Micro Systems, LLC. warrants to the original purchaser that the sign, keyboard, and power supply will be free of defects in workmanship and materials for a period of one year from the date of purchase.

Adaptive Micro Systems, LLC. will without charge, repair or replace, at its option, defective product or component parts upon delivery to the factory service department accompanied by proof of the date of purchase in the form of a sales receipt.

This warranty does not apply in the event of any misuse or abuse of the product, or as a result of any unauthorized repairs or alterations. This warranty does not apply if the serial number is altered, defaced or removed from the sign. Incandescent lamps used in incandescent products are not covered by this warranty.

The purchase price of this product does not include, from Adaptive Micro Systems, LLC, any on-site support, service or maintenance.

Local ordinances prohibiting the use of flashing signs may exist in some locations. Compliance with local ordinances is the sole responsibility of the customer.

To obtain warranty coverage, this product must be registered. Please complete the enclosed warranty registration card and mail it to Adaptive Micro Systems, LLC.

How to obtain warranty service

Contact the distributor from whom the sign was purchased. If you do not know where the product was purchased, contact Adaptive Micro Systems Customer Service at 414-357-2020.

1—Introduction

Purpose

This manual is intended as a guide for installation and setup of a Director sign, as well as for basic sign operation and text messaging.

Revision history

Revision	Date	Notes
9704-3006	08/26/1998	Installation and setup manual for wood Director only
9702-2005	11/15/2001	Installation and setup manual for aluminum Director only
9702-2005A	04/15/2002	Installation and setup manual for wood and aluminum Director
9702-2005B	10/27/03	Updates made to Adaptive's logo and trademark information.

Related documentation

Technical documentation can be found at Adaptive's Web site: <http://www.adaptivedisplays.com>.

Part #	Manual title	Description
9700-0112	Networking Alpha Signs	Describes how to network standard product Alpha signs.
9701-0202	Messaging Software User Manual	Provides step-by-step examples on how to use the Alpha Messaging Software Director Edition.
9707-1003	IR Message Loader Instructions	Explains how to use the Infrared Message Loader to transfer messages between display signs and PCs.
TechMemo 00-0005	Preventing Electrostatic Discharge (ESD) Damage	Describes grounding practices and provides work area guidelines when working on signs.

Preventing electrostatic discharge damage



This equipment contains components that may be damaged by “static electricity”, or electrostatic discharge. To prevent this from happening, be sure to follow the guidelines in Adaptive Tech Memo 00-0005, “*Preventing Electrostatic Discharge (ESD) Damage*,” available on our Web site at <http://www.adaptivedisplays.com>.

Safety information

Equipment symbols





Chassis ground

Warnings and cautions

⚠ WARNING	
	<p>Possible fire hazard. Always mount unit indoors. Mounting the unit outdoors may cause a fire which could result in serious injury or death.</p> <p style="text-align: right; font-size: small;">SM1007A</p>

⚠ WARNING	
	<p>Possible shock hazard. Always mount unit indoors. Mounting a unit outdoors makes the unit a possible source of electric shock which could result in serious injury or death.</p> <p style="text-align: right; font-size: small;">SM1001A</p>

⚠ WARNING	
	<p>Hazardous voltage. Contact with high voltage may cause death or serious injury. Always disconnect power to unit prior to servicing.</p> <p style="text-align: right; font-size: small;">SM1000A</p>

⚠ WARNING	
	<p>No circuit breaker or switch in sign. Contact with high voltage may cause death or serious injury. Always disconnect all power to sign prior to servicing.</p> <p style="text-align: right; font-size: small;">SM1010</p>

⚠ AVERTISSEMENT		⚠ WARNING
<p>COURANT DE FUITE ELEVE. Raccordement a la terre indispensable avant le raccordement au reseau.</p>		<p>HIGH LEAKAGE CURRENT. Earth connection essential before connecting supply.</p> <p style="text-align: right; font-size: small;">SM1009A</p>

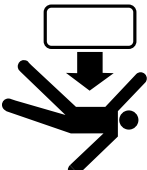
⚠ WARNING	
	<p>Possible crush hazard. Mounting system must be able to safely support the unit's weight. Otherwise the unit may fall, causing serious injury or death.</p> <p style="text-align: right; font-size: small;">SM1014</p>

⚠ WARNING	
	<p>Fasten sign to floor. Otherwise sign may tip over causing serious injury or death.</p> <p style="text-align: right; font-size: small;">SM1008A</p>

2—Equipment overview

The Director sign is an indoor LED sign that comes in either a wood or aluminum case. The sign can display up to eight 16-character (aluminum or wood) or 24-character (aluminum only) rows of text. The sign is capable of storing up to 26 screens of text information.

The sign can either be hung from a wall or mounted on a stand. An optional brochure rack can be used with the wood Director.

The power receptacle must be installed near the equipment and easily accessible.

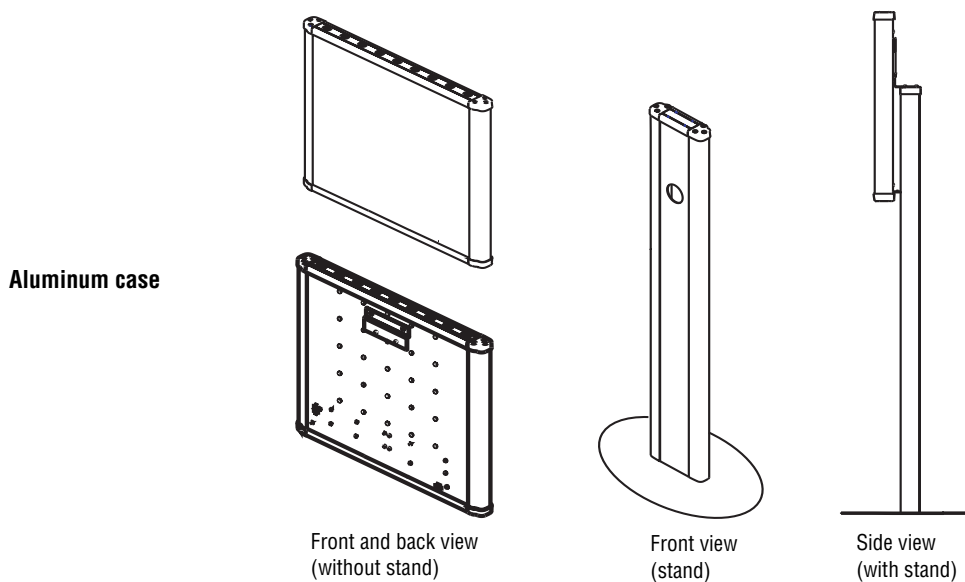
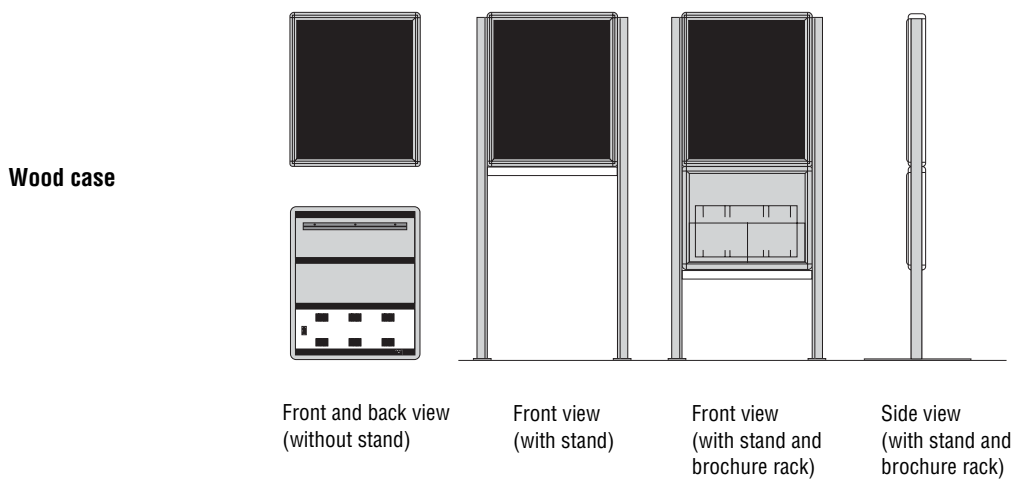

Technical specifications

Wood case

Item	Sign	Description
Power	16 character	120/230 VAC, 150 W
Dimensions (inches)	16 character	22.5L x 3.12D x 27H (57.2L x 7.9D x 68.6H cm)
Weight (without stand)	16 character	31.1 lbs. (14.1 kg)
Weight (with brochure rack and stand)	16 character	58.7 lbs. (26.6 kg)

Aluminum case

Item	Sign	Description
Power	16 character	100/240 VAC, 3.5 A, 50/60 Hz
	24 character	
Dimensions	16 character	25.45L x 2.82D x 27.49H (64.6L x 7.2D x 69.8H cm)
	24 character	35.03L x 2.82D x 27.49H (89.0L x 7.2D x 69.8H cm)
Weight (without stand)	16 character	*30 lbs. (13.6 kg)
	24 character	*40 lbs. (18.1 kg)
Weight (with stand)	16 character	*85 lbs. (38.6 kg)
	24 character	*95 lbs. (43.1 kg)
*Approximate		

EMI compliance

This equipment has been tested and found to comply with the limits for a Class A digital device, pursuant to Part 15 of the FCC Rules. These limits are designated to provide reasonable protection against harmful interference when the equipment is operated in a commercial environment. This equipment generates, uses, and can radiate radio frequency energy and, if not installed and used in accordance with the instruction manual, may cause harmful interference to radio communications. Operation of this equipment in a residential area is likely to cause harmful interference in which case the user will be required to correct the interference at his own expense.

3—Sign installation and setup

For more information on networking signs, see “Connecting signs to a computer” on page 23. For detailed information, see the **Networking Alpha Signs** manual, pn 9700-0112.

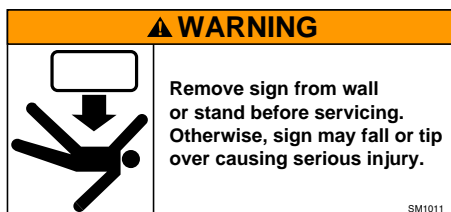
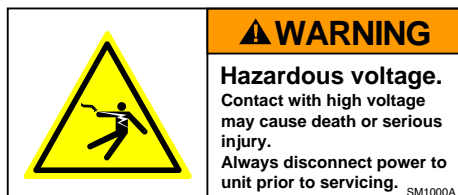

NOTE: Do not use the Director outdoors because water and dust will damage the sign.

NOTE: Because of its weight, the Director should be assembled by two people.

Mounting the wood Director

Wall mounting

1. Make sure a wall mounting bracket is attached to the back of the sign.

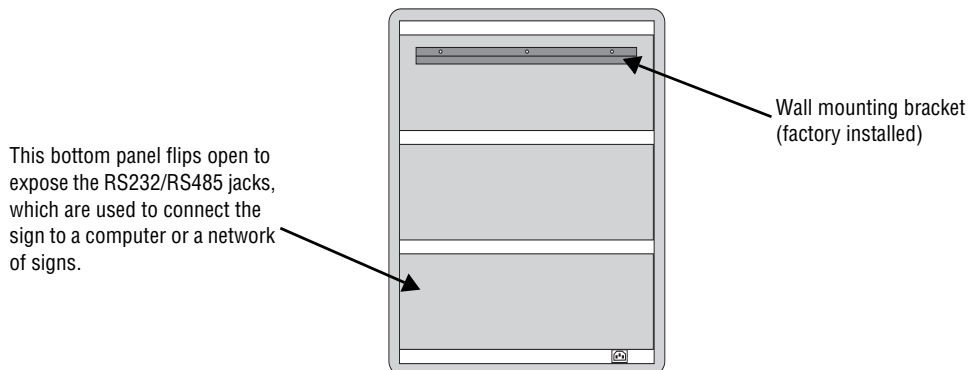

2. Attach the wall mounting bracket (supplied) to a wall. Then hang the sign from this bracket.

NOTE: Only hang this sign from a wall capable of supporting 116 pounds (52.5 kg).

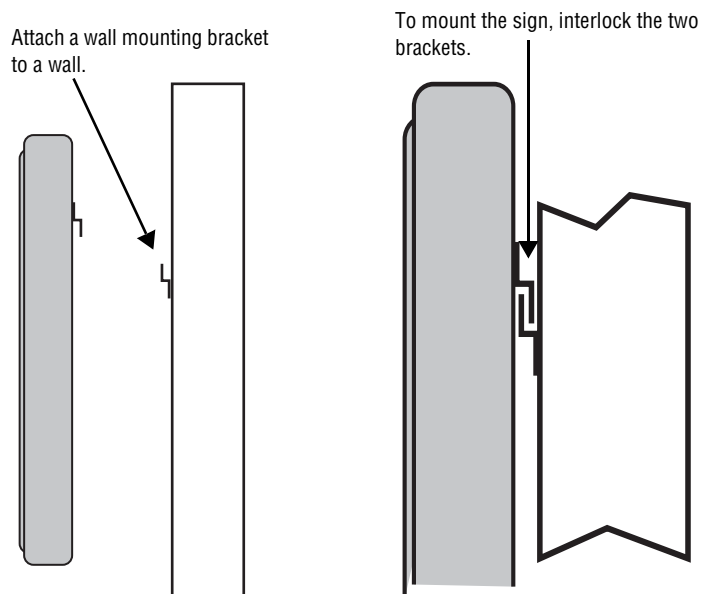

3. Route the power cord from the sign in such a way that the cord is not in an area where people will be walking.

Stand mounting (without brochure rack)

1. Remove the caps from the top of each mounting pole.

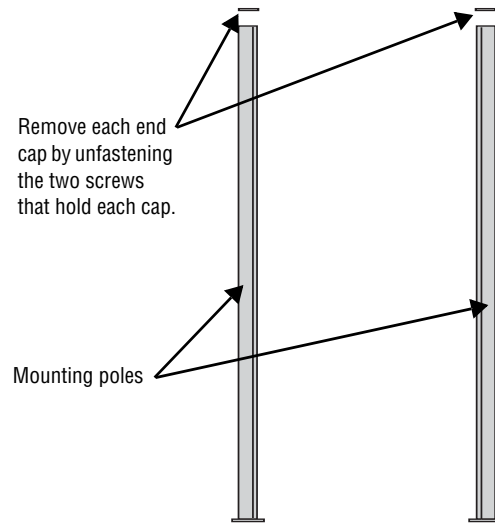

2. Place both mounting poles on a flat surface. Slide the crossbar down the channels on the mounting poles. Then slide a safety stop down each channel.

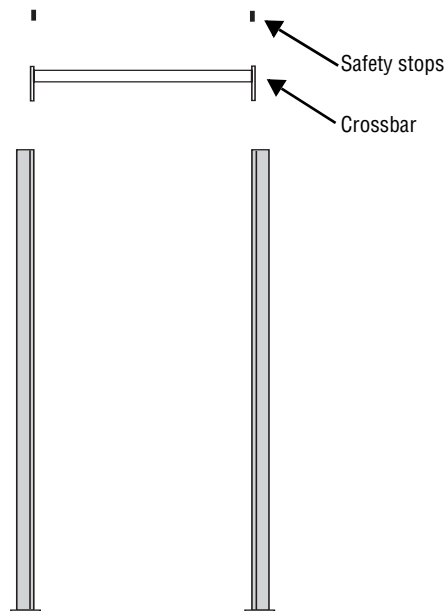

3. Fasten the crossbar to each mounting pole with the four set screws. Then fasten each safety stop with the two sets of screws.

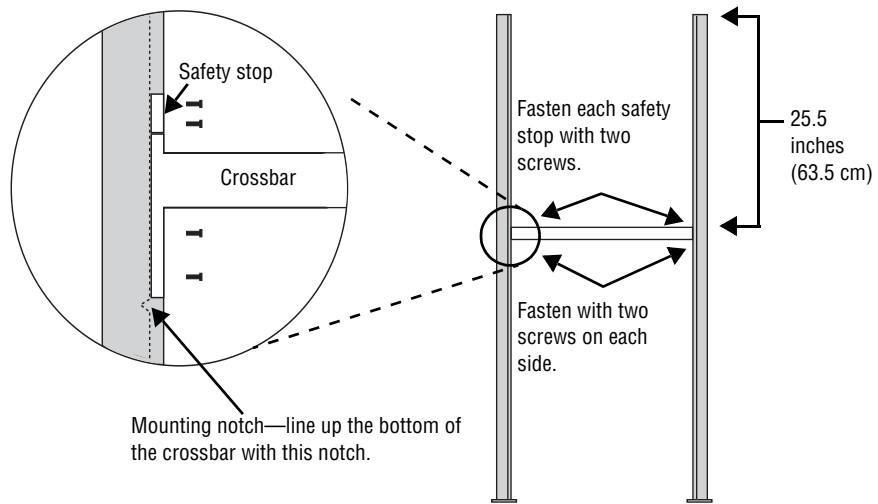

NOTE: Screws should be securely tightened (18- to 20-inch/pounds of torque recommended).

4. Place each of the sign's mounting brackets in a channel on each mounting pole. Then slide the sign down until it rests on the safety stops. Finally, reattach the end caps to the tops of the mounting poles.

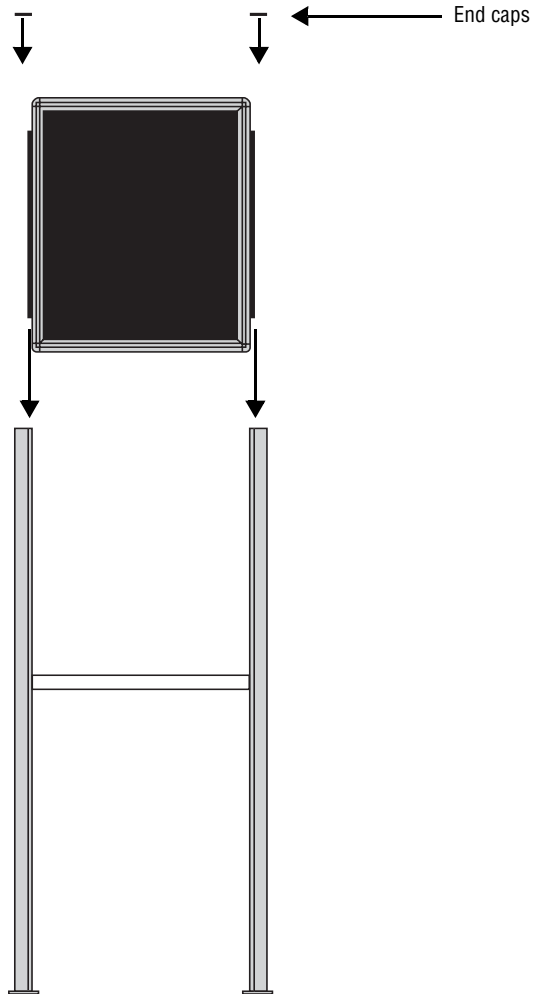

5. Fasten the sign to the floor using four bolts or screws (not provided) in the locations shown below.

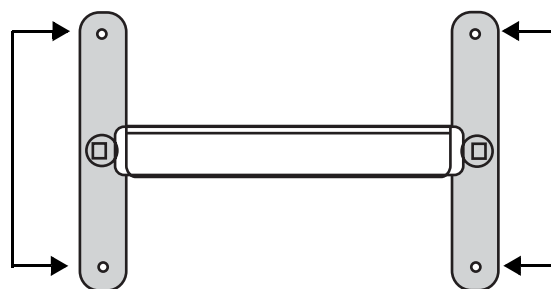

Top view of sign

6. Route the power cord from the sign in such a way that the cord is not in an area where people will be walking.

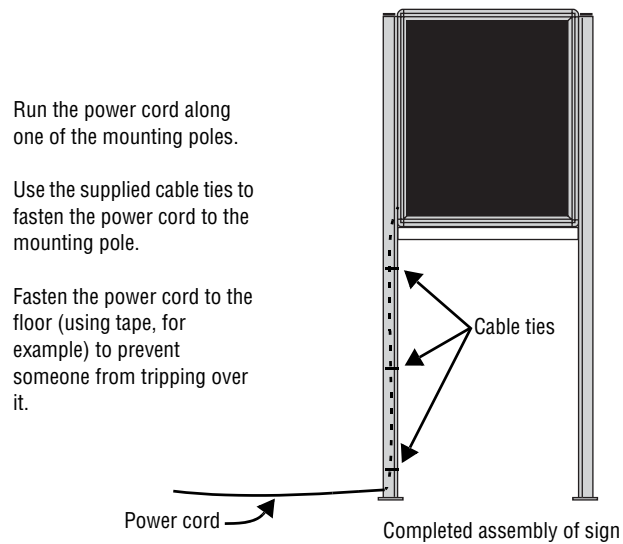

Stand mounting (with brochure rack)

1. Remove the caps from the top of each mounting pole.

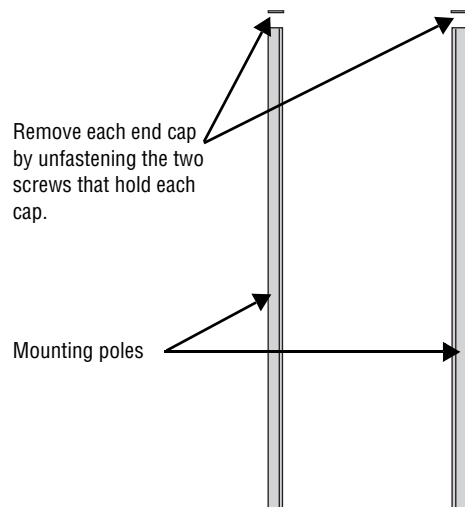

2. Place both mounting poles on a flat surface. Slide the crossbar down the channels on the mounting poles. Then slide a safety stop down each channel.

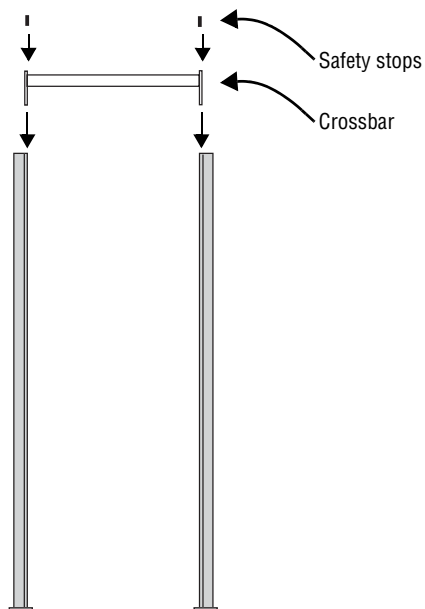

3. Fasten the crossbar to each mounting pole with the four set screws. Then fasten each safety stop with the two sets of screws.

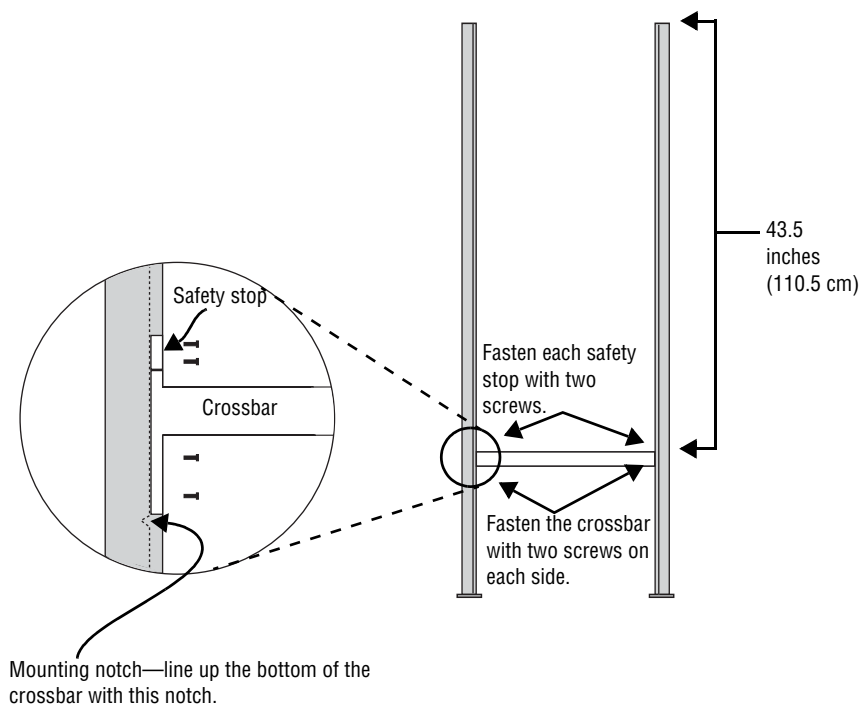

NOTE: Screws should be securely tightened (18- to 20-inch/pounds of torque recommended).

4. Place each of the brochure rack's mounting brackets in a channel on each mounting pole. Slide the brochure rack down until it rests on the safety stops. Then slide the sign down the channels. Finally, reattach the end caps onto the tops of the mounting poles.

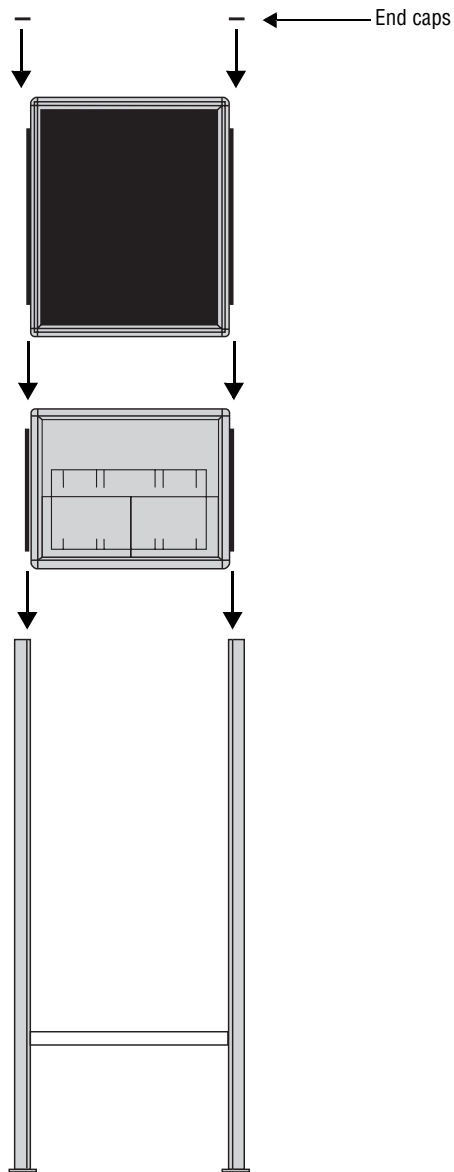

- Fasten the sign to the floor using four bolts or screws (not provided) in the locations shown below.

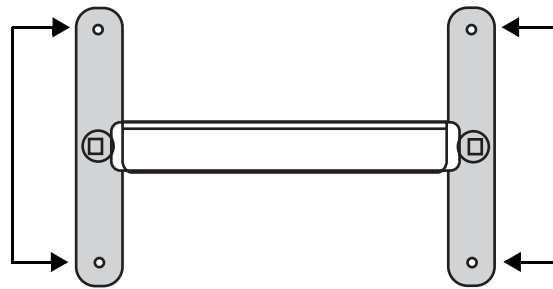

Top view of sign

- Route the power cord from the sign in such a way that the cord is not in an area where people will be walking.

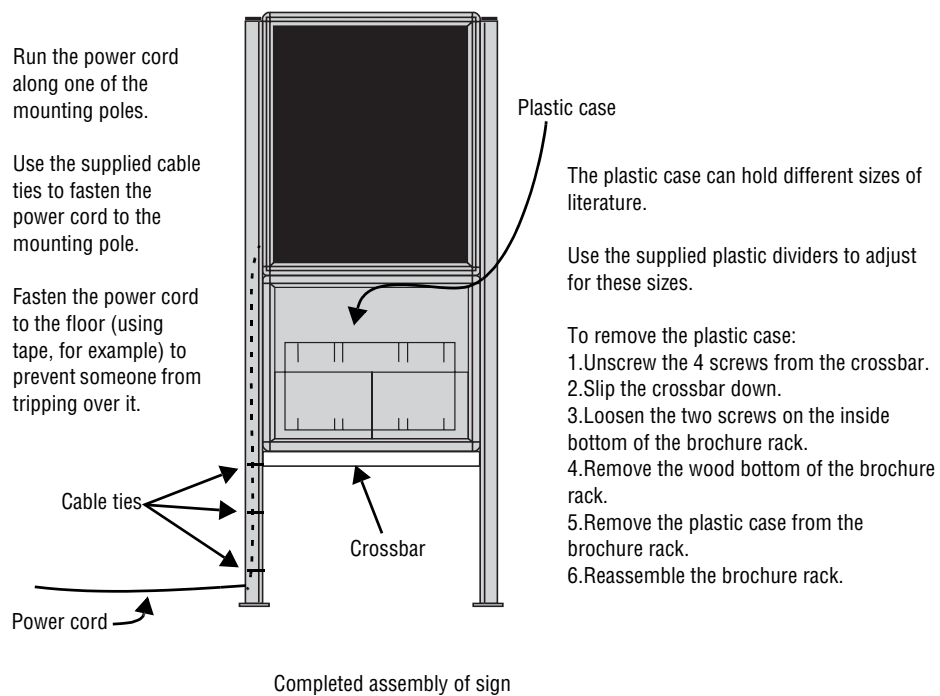

Mounting the aluminum Director

Wall mounting

1. Make sure a mounting bracket is attached to the back of the sign.

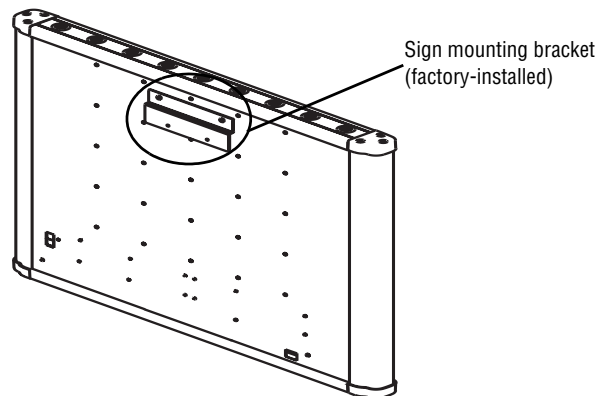

2. Attach the wall mounting bracket to a wall with fasteners (not provided). Then hang the sign from this bracket.

NOTE: Both the wall and the fasteners must be capable of supporting 120 pounds (54.5 kg).

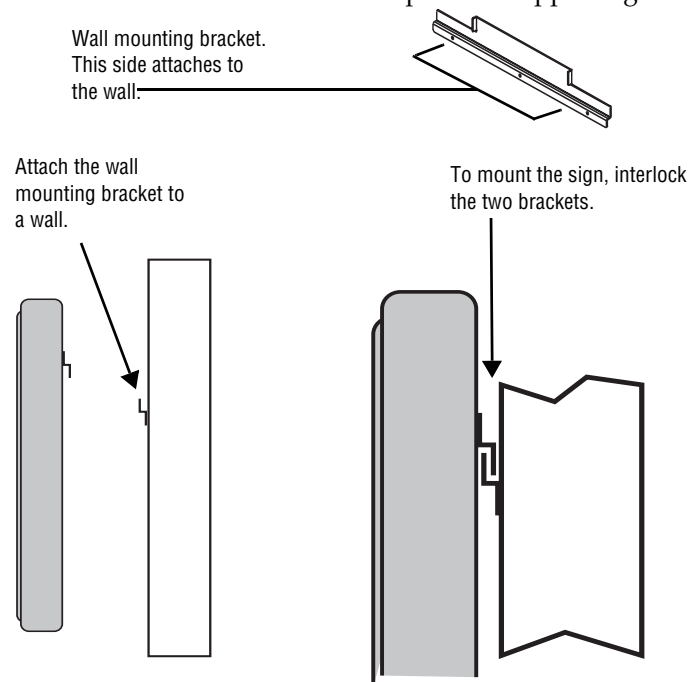

3. Plug the power cord into the back of the sign and route it from the sign in such a way that it is not in an area where people will be walking.

Stand mounting

1. Assemble the stand by attaching the pole to the base plate using six 1/4-20 x 1.25 inch Phillips flathead screws.

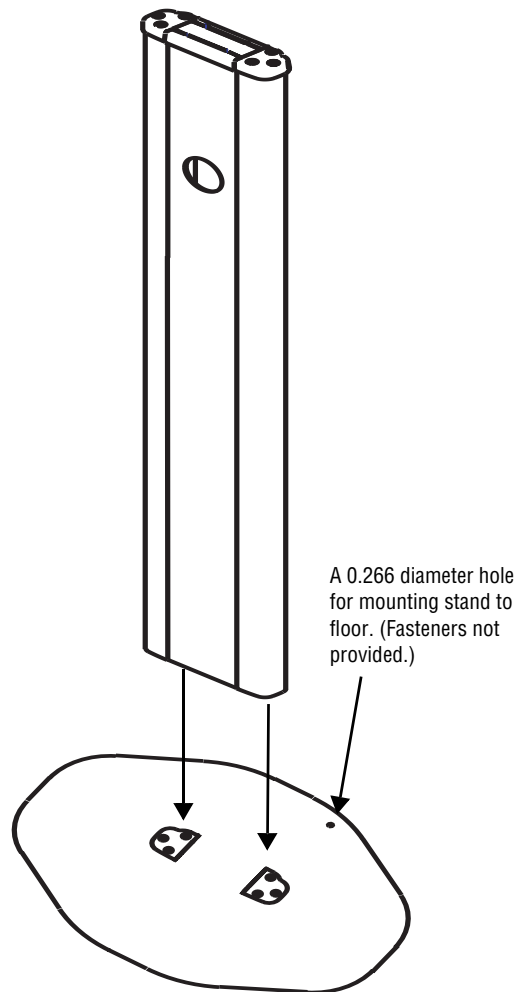

2. Attach the bottom bracket to the back of the sign, and to the front and top of the stand. Then attach the sign to the stand.

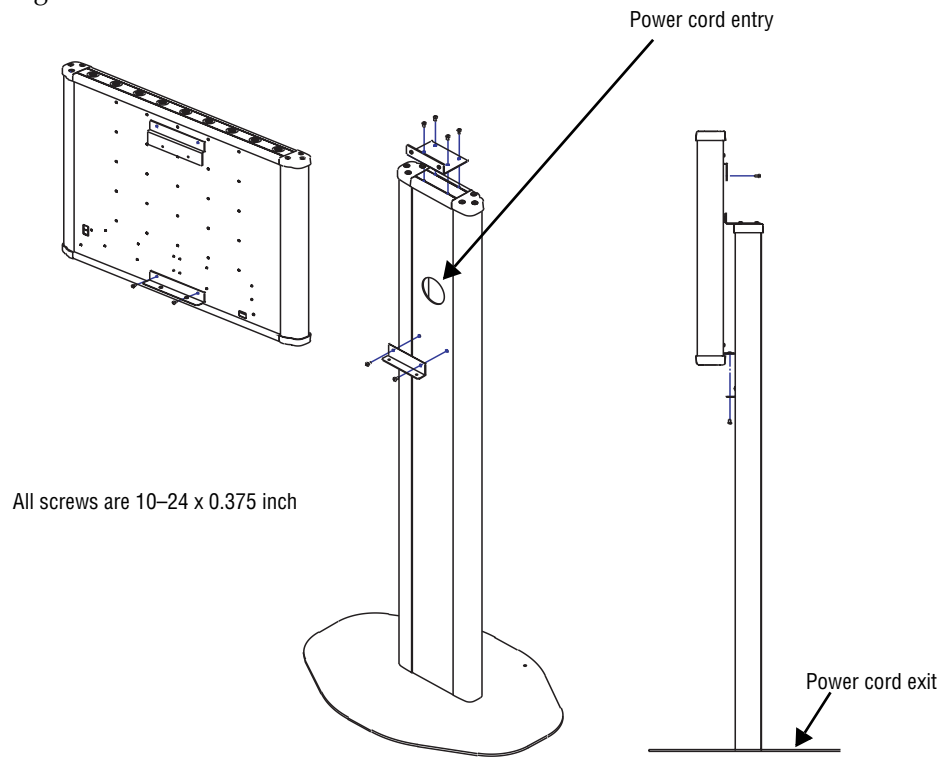

3. Plug the power cord into the back of the sign. Run the cord through the power cord entry on the front of the stand, down the interior of the stand, then out the power cord exit.

Connecting signs to a computer

Connect the sign to a computer in order to send messages to it using Alpha Messaging Software Director Edition.

One sign to one computer

1. Remove power from the sign.

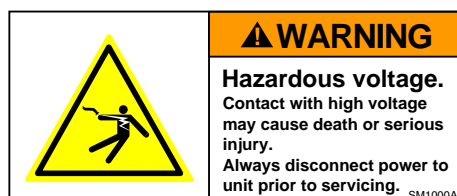

2. If you are connecting a wood Director, make sure the sign's internal RS232/RS485 jumper is set to RS232. The jumper is set automatically in the aluminum Director.

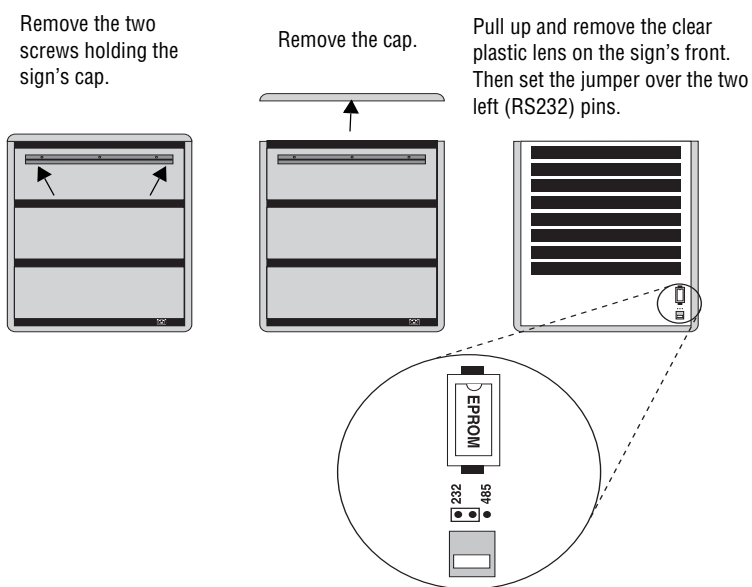

3. Connect a personal computer to the sign as shown.

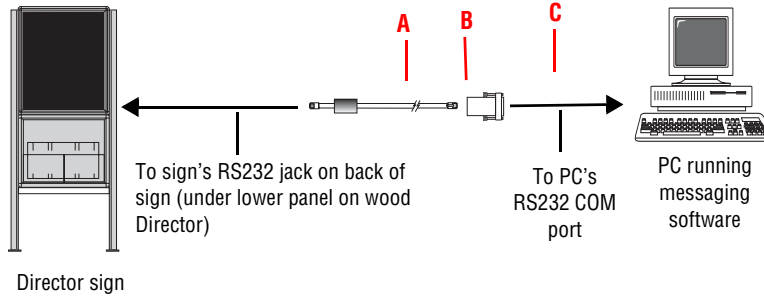

Item	Part #	Description
A	—	Ferrite (ferrite end towards sign)
B	1088-8625	25-foot RS232 cable
	1088-8627	50-foot RS232 cable
C	4370-0001C	RJ11-to-DB25 adapter (for a PC with a 25-pin RS232 port)
	1088-9108	RJ11-to-DB9 adapter (for a PC with a 9-pin RS232 port)
Note: Part number 1036-9010, a 6-connector RS232 cable, can replace pn 1088-8625 and pn 1088-9108.		

Multiple signs to a network

Because there are a variety of ways (for example, LAN, wireless, Ethernet, and so on) to connect networked signs, see the **Networking Alpha Signs** manual, PN 9700-0112, for more information.

On a wood Director, the sign's internal RS232/RS485 jumper must be set to RS485. See page 23 for more information on setting the jumper.

4—Software installation and setup

Messages can be sent to Director signs using either of two methods, the Alpha Messaging Software Director Edition or the hand-held remote control.

The **Messaging Software User Manual**, PN 9701-0202, is included in the installation of the software to provide you with specific information on how to send messages to a Director sign with the Director edition messaging software. It is located in your Windows Start menu (*Programs>Alpha Messaging Software Director Edition>User Manual*).

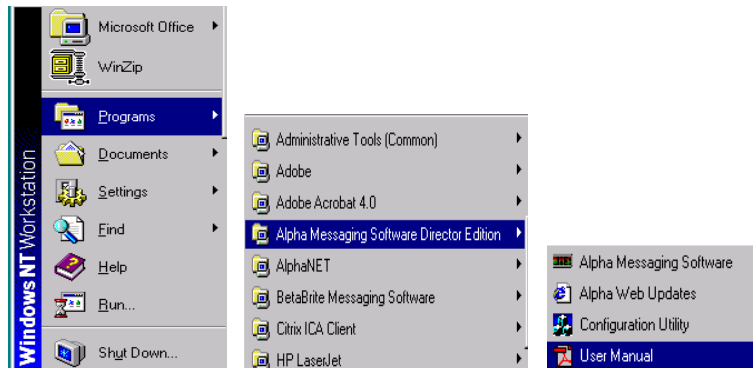

NOTE: Online help is available in the Director edition messaging software. It contains jumps to related topics for immediate access to the information you need, as well as popup windows that provide window-specific information that will help you move through the various procedures. Press the F1 key to access this help when in the software.

The other way messages can be sent to the Director signs is by using a hand-held remote control. Information on text messaging with the remote is found starting on page 28.

Installing the software

1. Start Microsoft Windows and be sure to have all other applications closed.
2. Insert the Alpha Messaging Software Director Edition CD-ROM into your CD-ROM drive. The installation process will start automatically.

NOTE: If the installation does not start automatically, run the install through your Windows *Start>Run* menu, or double-click *Setup.exe* in your CD-ROM drive folder.

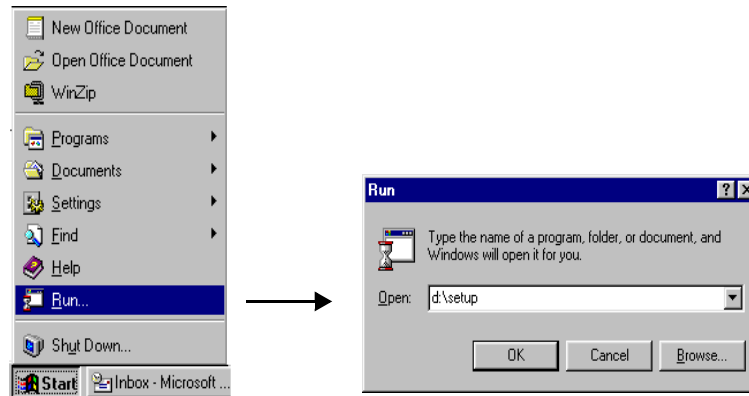

3. Follow the instructions when the installation program prompts you for a response. You will be given a choice as to which size Director display you want to send messages (the 16-character per line or the 24-character per line). Your choice determines what will appear in the title bar of the Alpha Messaging Software Director Edition. You will also be given a chance to install Acrobat Reader, which you will need to view the messaging software manual included.
4. When the installation program is complete, the Alpha Messaging Software Director Edition appears in your *Start* menu.

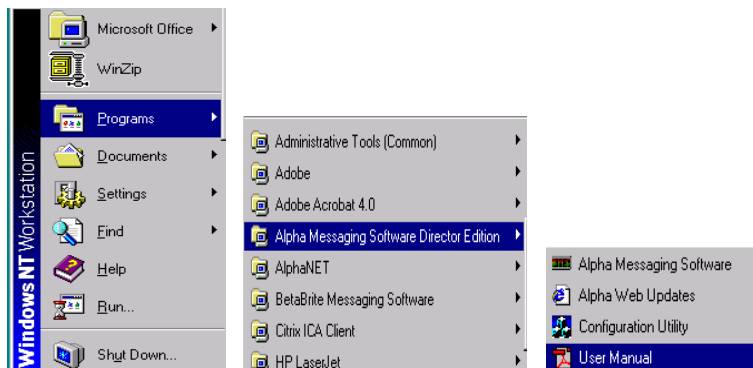

Setting up the software

Do the following only when you want to use a COM port other than COM1 (the default COM port):

1. Double-click *Configuration Utility* in the *Start>Programs>Alpha Messaging Software Director Edition* menu.

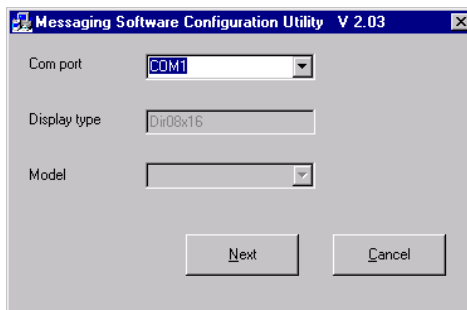

2. Select the appropriate COM port from the drop-down menu and click *Next*.
3. Select the type of Director sign to which you want to send messages or click *Detect* to have the software do it for you. Then click *OK*. The Configuration Utility will close automatically.
4. Open the software by double-clicking *Start>Programs>Alpha Messaging Software Director Edition>Alpha Messaging Software*.

5—Using the remote control

Overview

The remote control is a hand-held keyboard which emits infrared light and is used to program a sign. The remote control needs four AAA batteries to operate. They should be installed in the back of the control.

The remote control can be used to turn a sign on and off, or to set its serial address. It can also be used to set its time and date, and to clear memory.

However, the remote control's most important—and most used—purpose is the creation of text messages and graphic images on a sign.

To show you how to use the remote control, this manual presents practical, everyday examples.

NOTE: A sign (or a network of signs) can also be programmed using a personal computer and special software. See the **Networking Alpha Signs** manual, PN 9700-0112, and your messaging software user manual for more detailed information.)

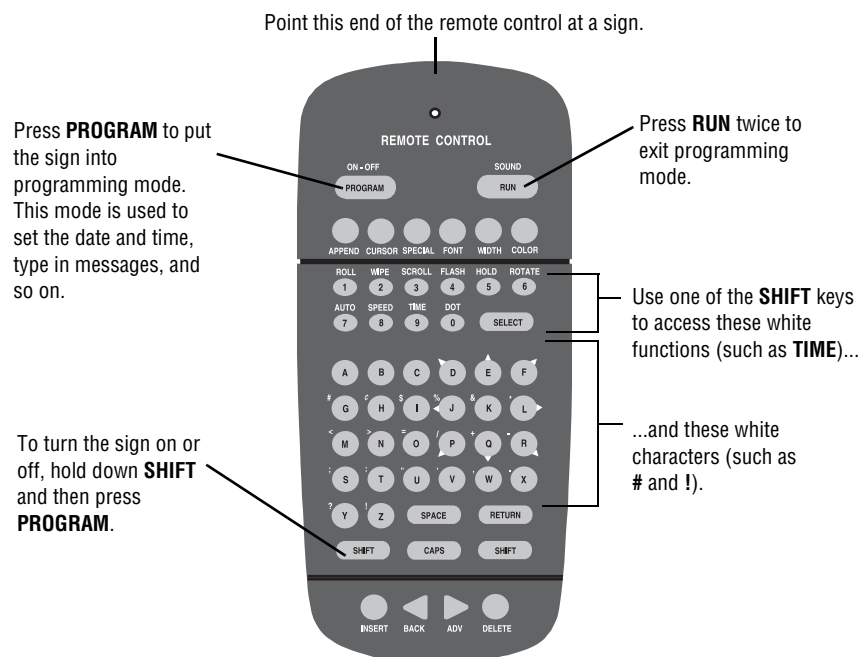

To use the remote control:

- Stand at least 5 feet and no more than 30 feet from the sign.
- Make sure nothing reflective is in front of the sign. (Light from the sign's display that is reflected back can interfere with the remote control.)

- If nearby fluorescent lights interfere with the remote control, you may have to relocate either the lights or the sign.

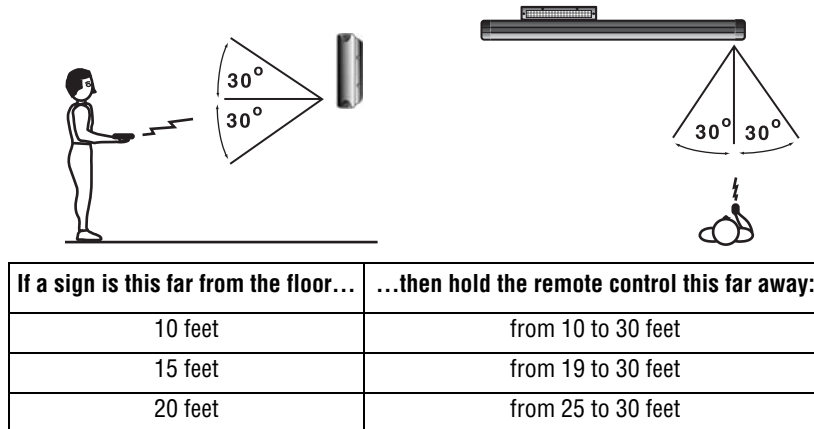

Turning a sign on and off

When you plug in the sign’s power supply, the sign starts up automatically, and unplugging the power supply turns the sign off.

However, instead of unplugging a sign, there is another way to turn a sign off. Using the remote control, hold down **SHIFT** and then press **PROGRAM**.



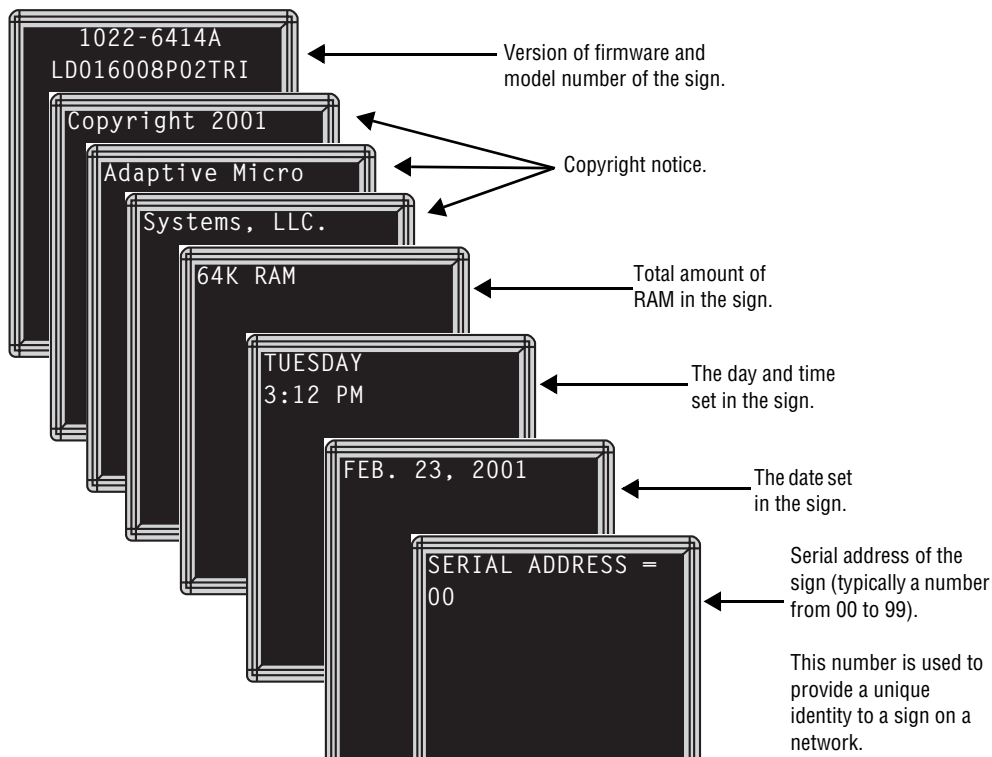

NOTE: Messages that you have programmed into the sign will not be lost when you turn a sign off. Messages will be retained for up to 30 days if the sign is not powered.



When you turn a sign on, information similar to the following will appear:

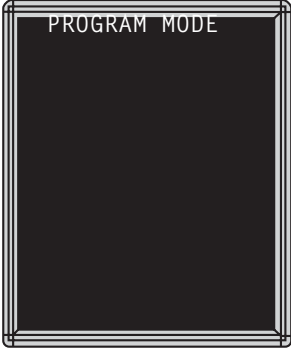

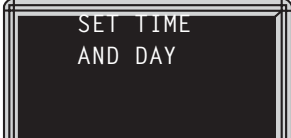
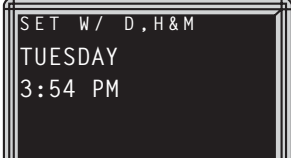
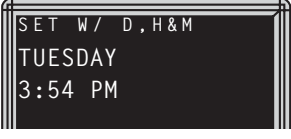
Setting a sign's time and date



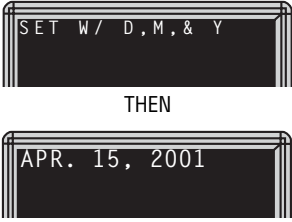

Once set, a sign will remember the time and date for up to 30 days, even if the sign is unplugged or interrupted by a power loss. This is because it is equipped with a battery-backed real-time clock.

Step	When you do this...	You see this...
1	Press PROGRAM .	 <p>PROGRAM MODE</p> <p>THEN</p>  <p>PAGE A MODE: [AUT] SPEED: [SP4]</p>
2	Press BACK until <i>SET TIME AND DAY</i> appears.	 <p>SET TIME AND DAY</p>
3	Press ADV .	 <p>SET W/ D, H&M TUESDAY 3:54 PM</p>
4	Press D to set the day of the week. Press H to set the hour. Press M to set the minute. NOTE: Press SELECT to change from 12- (AM/PM) to 24-hour mode (0–23).	 <p>SET W/ D, H&M TUESDAY 3:54 PM</p>
5	Press BACK until <i>SET DATE</i> appears.	 <p>SET DATE</p>

<p>6</p>	<p>Press ADV.</p>	 <p>Diagram illustrating the display sequence: 'SET W/ D,M,& Y' followed by 'THEN' and 'APR. 15, 2001'.</p>
<p>7</p>	<p>Press D to set the correct day. Press M to set the month. Press Y to set the year.</p> <p>NOTE: Press SELECT to display the date in different formats—for example, APR 15, 2001 or 4/15/01, or 15/4/01, and so on.</p>	 <p>Diagram illustrating the display: 'APR. 15, 2001'.</p>
<p>8</p>	<p>After setting the date and time, press RUN twice to return to normal operation.</p>	

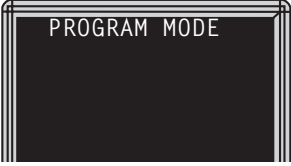
Clearing a sign's memory

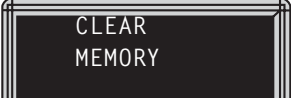

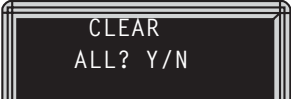





Clearing a sign's memory erases the password and all messages that have been programmed into the sign.



Step	When you do this...	You see this...
1	Press PROGRAM .	 <p>PROGRAM MODE</p> <p>THEN</p>  <p>PAGE A MODE: [AUT] SPEED:[SP4]</p>
2	Press BACK until <i>CLEAR MEMORY</i> appears.	 <p>CLEAR MEMORY</p>
3	Press ADV .	 <p>WARNING *****</p> <p>THEN</p>  <p>CLEAR ALL? Y/N</p>
4	Press Y to clear the sign's memory. The sign will return to normal operation and display a series of demo messages.	

Setting a sign's password



You can set a personal password to protect your messages from tampering by others. If you forget your password, you won't be able to operate the sign until you follow the steps on "Forgetting a sign's password" on page 34.

How to set a sign's password

Step	When you do this...	You see this...
1	Press PROGRAM .	 
2	Press BACK until <i>SET PASSWORD</i> appears.	
3	Press ADV .	
4	Press Y to set a password.	
5	<p>Type a 6-character password. (Only asterisks will appear on the sign as you type.)</p> <p>Retype the password when prompted.</p> <p><i>CORRECT</i> appears if you entered the same password.</p> <p>If you failed to type the same password, <i>ERROR</i> will appear, and you'll have to start over from step 1.</p>	 <p>THEN</p>  <p>THEN</p>  <p>THEN</p> 

6	Press RUN twice.	
7	Press Y to password protect the sign. NOTE: If you select N , a password will not be needed when you press PROGRAM .	 <p>The sign will return to normal operation. Now, whenever you press PROGRAM, you'll have to type the password you just entered.</p>

Forgetting a sign's password

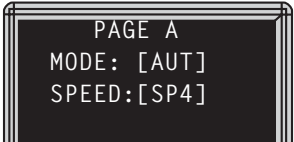
Step	When you do this...	You see this...
1	Press PROGRAM .	
2	Hold down SHIFT and press L six times.	 <p>THEN</p> 
3	Enter a new password. (See "Setting a sign's password" on page 33.)	

Deleting a sign's password

If you no longer want to be prompted to password protect a sign, you must clear the sign's memory in order to delete the password. To do this, see "Clearing a sign's memory" on page 32.



Using the remote control's sound control

Normally, whenever you press a remote control key, the sign will beep. This lets you know that an action has been performed. To turn this feature off (or on again), hold down **SHIFT** and press **RUN**.

Setting a sign's serial address

The serial address is a number that you can assign to a sign. Typically, this feature is used with a sign that is connected to other signs on a network. Giving a unique serial address to a sign allows you to send messages to that particular sign only.

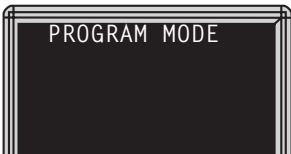
See the **Networking Alpha Signs** manual, PN 9700-0112, for detailed information on networking signs.

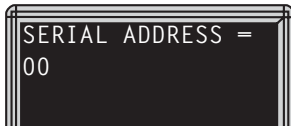
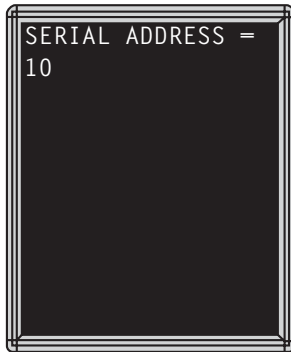
Step	When you do this...	You see this...
1	Press PROGRAM .	
2	Press BACK until <i>SET SERIAL ADDRESS</i> appears.	
3	Press ADV .	
4	Type a number, such as 10 . NOTE: A serial address is actually a number from 0 to 255 in hexadecimal (00 to FF). However, in typical use, entering a number from 00 to 99 is fine. NOTE: When a sign leaves the factory, its serial address is set to 00.	
5	Press RUN twice to set the new serial address and return the sign to normal operation.	



6—Beginning text messaging



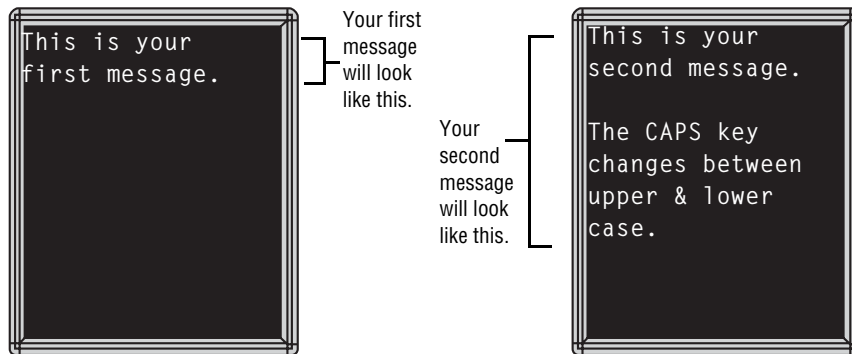

This section shows you how to start creating messages for your sign using the remote control.



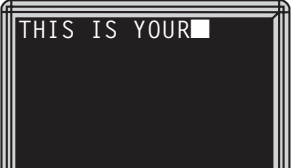



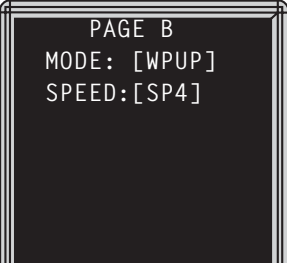

Example 1—Using upper and lowercase text

In this first example, you'll display the following text on the sign:



Step	When you do this...	You see this...
1	Press PROGRAM .	<p>Modes allow you to use a special effect, like flashing, on a message. In this case, AUTOMODE [AUT] is used. To change the mode, hold down SHIFT and press either 2 (WIPE), 4 (FLASH), 5 (HOLD), or 7 (AUTO).</p> <p>SPEED controls how fast a mode changes. To change SPEED, hold down SHIFT and press 8. [SP5] is the fastest speed and [SP1] is the slowest. [NHL] means "no hold".</p> 
2	Press ADV .	 <p>Blinking cursor</p>
3	Type THIS IS YOUR . NOTE: If you make a mistake while typing, press BACK to erase a letter.	

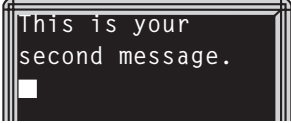

4	Press RETURN to go to the next line.	
5	Type FIRST MESSAGE . NOTE: To create the period (.), hold down SHIFT and press X .	
6	Press RUN to display your first message.	Because AUTOMODE [AUT] was used, the message will appear in different colors. 
Here's how to create the second message:		
7	Press PROGRAM .	
8	Press B to switch to PAGE B.	Your second message will be created in PAGE B. (Your first message is still in PAGE A. You can create up to 26 separate messages using pages A through Z.) 

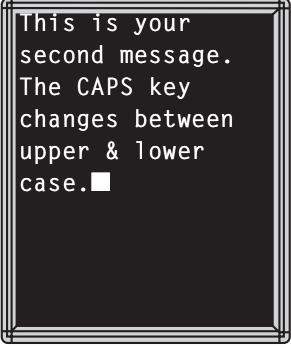
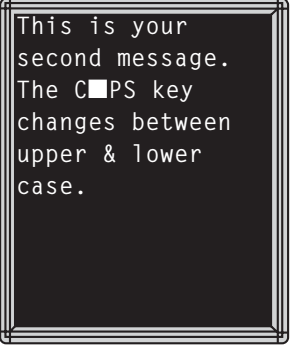
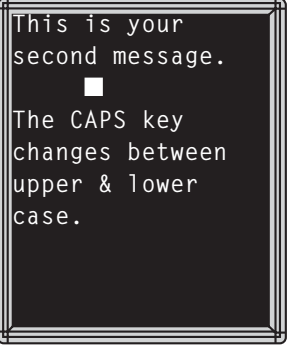
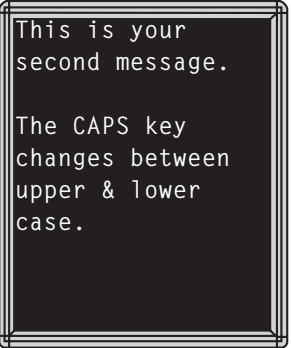
9	Hold down SHIFT and then press 2 for WIPE.	 <p>WPUP = wipe up.</p> <p>← If you hold down SHIFT and press 2 again, the mode will change to WPDN (WIPE DOWN). You can also select wipe left and wipe right.</p>
10	Press ADV .	
11	Press the round COLOR key until the cursor color stays green.	
12	Type T .	
13	Press CAPS to change to lowercase text. Then type his is your .	<p>All these characters in this line should be green. →</p> 
14	Press RETURN to go to the next line.	
15	Press the round COLOR key until the cursor color stays red.	
16	Type second message .	<p>All these characters in this line should be red. →</p> 
17	Press RETURN to go to the next line.	
18	Press the round COLOR key until the cursor color stays amber.	

<p>19</p>	<p>Using CAPS, SHIFT, and RETURN when necessary, type the following: The CAPS key changes between upper & lower case.</p> <p>NOTE: The ampersand (&) is made by holding down SHIFT and pressing K.</p>	<p>All these characters in these lines should be amber.</p> 
<p>Here's how to insert a blank line between the two sentences above.</p>		
<p>20</p>	<p>Hold down SHIFT and press E to move the cursor up one line.</p> <p>Repeat this until the cursor is over the <i>A</i> in <i>CAPS</i>.</p>	
<p>21</p>	<p>Press INSERT to create a blank line.</p>	<p>Use INSERT to create blank lines between text. →</p> <p>(Use DELETE to remove blank lines.)</p> 
<p>22</p>	<p>Press RUN to see the message.</p>	<p>Notice that only the second message (PAGE B) is displayed.</p> <p>In the next example, you'll see how to display multiple messages instead of just one.</p> 

Example 2—Displaying messages in PAGE name order (A, B, C)

Once you've programmed messages into the sign, you may want to set the order or sequence in which messages appear. This method will display messages by their PAGE name (A, B, C, and so on) in the order you set (C, A, B, for example). If you do not set the sequence, the messages will appear in alphabetical order.

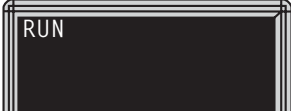
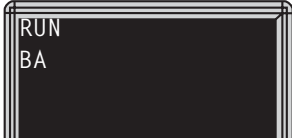

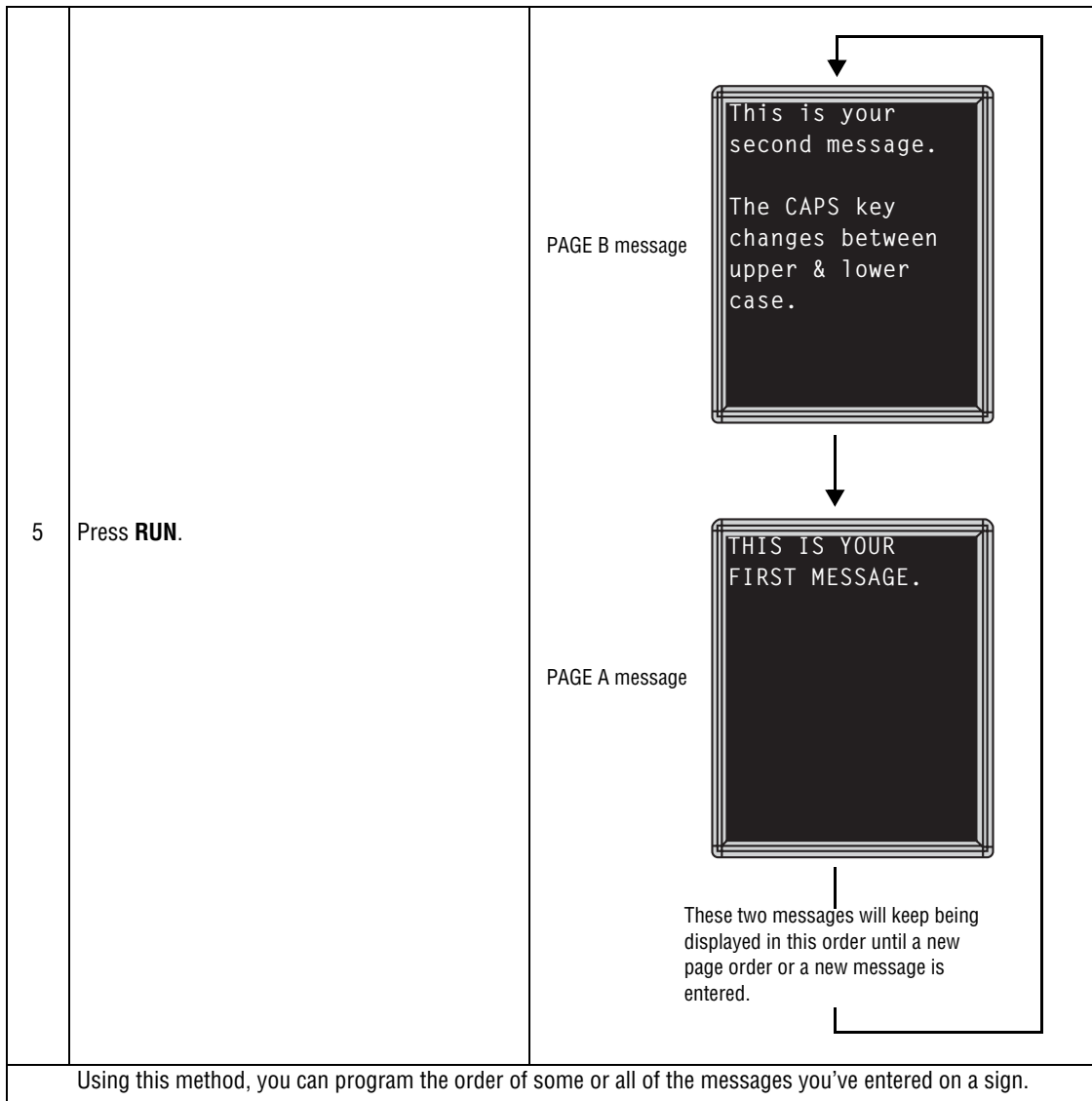
Step	When you do this...	You see this...
<p>This example continues where Example 1 left off. This example assumes that there are two messages (PAGE A and B) in the sign.</p>		
1	Press PROGRAM .	<p>Since we're continuing from Example 1, this would appear on the sign.</p> 
2	Press RUN .	<p><i>DEMO</i> or <i>RUN</i> may also appear here. →</p> <p><i>TIM</i> = displays messages in time order. <i>DEMO</i> = displays a set of demonstration messages. <i>RUN</i> = displays messages by PAGE order (A, B, C, and so on).</p> 
3	<p>If <i>RUN</i> appears on the sign, go to the next step. Otherwise, press SELECT until <i>RUN</i> appears.</p>	
4	Press B and then A .	<p>This will be the order (PAGE B, then PAGE A) in which messages are displayed on the sign. →</p> 







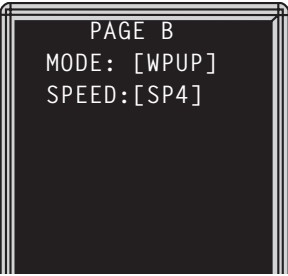
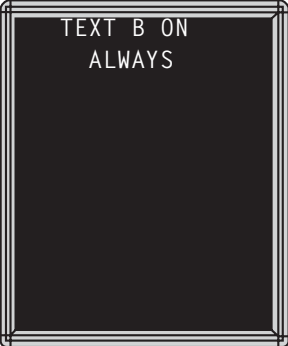
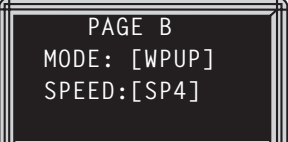
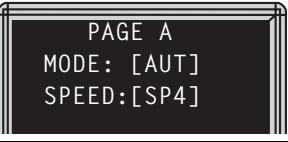

Example 3 — Displaying messages in time order

In Example 2, you set the order of messages by PAGE letter (A, B, C, and so on). However, that method could not specify an exact time when a message would appear.



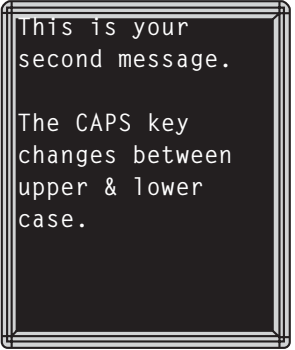

In this example, we'll show you how to make a message start and stop at times you specify.



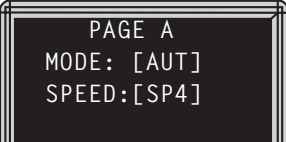

Step	When you do this...	You see this...
<p>For this example, make sure that your sign's internal clock has been accurately set. (See "Setting a sign's time and date" on page 30.)</p> <p>This example continues where Example 1 left off. This example assumes that there are two messages (PAGE A and B) in the sign.</p> <p>In this example, we'll program the sign to display the message in PAGE A on Monday through Friday from 1:20 PM to 1:30 PM. We'll program the sign to always display the message in PAGE B.</p>		
1	<p>Press PROGRAM.</p> <p>(If <i>PAGE B</i> does not appear, press B to display it.)</p>	<p>Since we're continuing from Example 1, this would appear on the sign.</p> 
2	<p>Hold down SHIFT and press 9 for TIME.</p>	<p><i>ON ALWAYS</i> is the default setting for a message. A message set to <i>ON ALWAYS</i> will run continuously.</p>  <p>Since PAGE B is already set up, we'll go on to PAGE A.</p>
3	<p>Press RUN twice.</p> <p>Then press PROGRAM.</p>	
4	<p>Press A.</p>	
5	<p>Hold down SHIFT and press 9 for TIME.</p>	

First we'll set the ON time (when this message will start on the sign):		
6	Press D (for day) until <i>MO-FR</i> appears.	 <p>Press D to set the day, H for hour, and M for minute (in 10-minute increments).</p>
7	Press H (for hour) until <i>13:00</i> appears.	 <p>Hours are represented in 24-hour or military style. So 1:00 PM = 13:00, 2:00 PM = 14:00, and so on.</p>
8	Press M (for minute) until <i>13:20</i> appears.	 <p>Minutes are in increments of 10.</p>
9	Press SELECT .	 <p>After setting the on time, we'll select the off time (when the message stops).</p>
10	Repeat steps 6, 7, and 8 to set an off time (in this case, 13:30).	
11	Press RUN twice.	<p>This message should appear continuously. — PAGE B</p>  <p>This message should only appear between the on and off times you set. — PAGE A</p> 

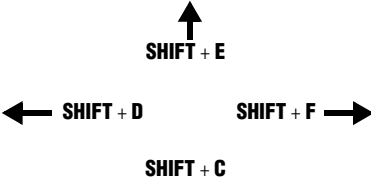
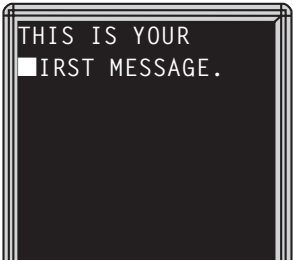
Example 4 — Changing the text of an existing message

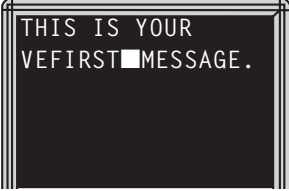
After typing in a message, you may want to add or remove text from it. The following is an example of this common situation:

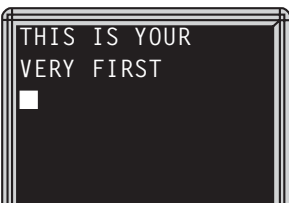
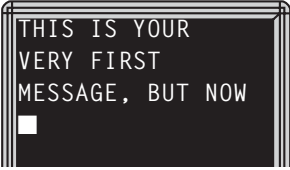
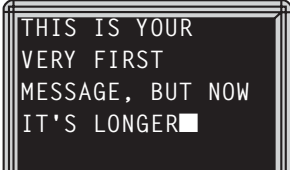
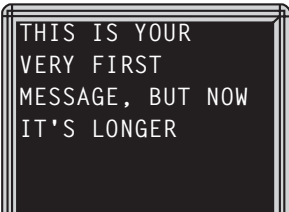

Step	When you do this...	You see this...
<p>This example continues where Example 2 left off. This example assumes that there are two messages (PAGE A and B) in the sign. In this example, we'll change PAGE A to the following: <i>THIS IS YOUR VERY FIRST MESSAGE, BUT NOW IT'S LONGER</i></p>		
1	Press PROGRAM .	
2	Press RUN . Press SELECT until <i>RUN</i> appears. Press A and then B to set a run sequence. Finally, press RUN again.	
3	Press PROGRAM . (If <i>PAGE A</i> does not display, press A .)	
4	Press ADV .	The cursor should be blinking over the first letter. 
5	Hold down SHIFT and press C to move the cursor down one line.	<p>How to move the cursor:</p> <p style="text-align: center;">  </p> <p>The cursor should be blinking over the first letter on the second line.</p> 

6	Try to type the word VERY .	<p>You'll only be allowed to type the first two letters of <i>VERY</i>, because there must be enough room in a line to add the characters.</p> 
7	<p>In order to make room for the word <i>VERY</i>, you'll have to delete the word <i>MESSAGE</i> first.</p> <p>Move the cursor to the end of the word <i>FIRST</i> by holding down SHIFT and then pressing F.</p>	
8	Press DELETE until the word <i>MESSAGE</i> (and the period) is deleted.	
9	Hold down SHIFT and press D to move the cursor over the letter <i>F</i> .	
10	Finish the word <i>VERY</i> by typing RY and a space.	
11	<p>Hold down SHIFT and press C to move down one line.</p> <p>Then hold down SHIFT and press D until the cursor is at the start of the line.</p>	
12	Type MESSAGE, BUT NOW .	<p>The cursor moves to the next line automatically.</p> <p>Use SHIFT + W to create a comma.</p> 
13	Type IT'S LONGER .	<p>Use SHIFT + V to create an apostrophe.</p> 
14	Press RUN to see your message.	

Example 5 — Deleting messages

To delete all the messages in a sign, see “Clearing a sign’s memory” on page 32.



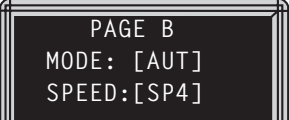
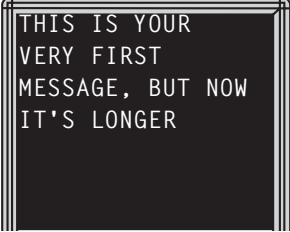



However, if you only want to delete selected messages, then use the method shown in this example.

Step	When you do this...	You see this...
<p>This example continues where Example 4 left off. This example assumes that there are two messages (PAGE A and B) in the sign: PAGE A = <i>THIS IS YOUR VERY FIRST MESSAGE, BUT NOW IT'S LONGER</i> PAGE B = <i>This is your second message. The CAPS key changes between upper & lower case.</i></p> <p>In this example, we'll delete the PAGE B message:</p>		
1	<p>Press PROGRAM. (If <i>PAGE B</i> does not display, then press B.)</p>	
2	<p>Press DELETE.</p>	
3	<p>Press Y to delete the page.</p>	
4	<p>Press RUN twice.</p>	<p>Only the PAGE A message should appear.</p> 





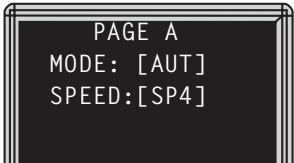
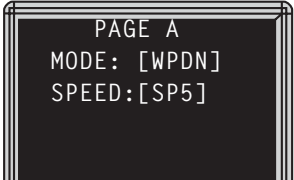

7—Advanced text messaging

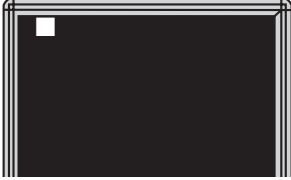
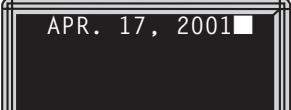
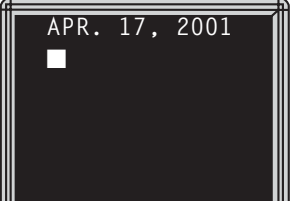
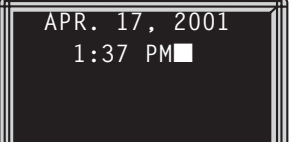
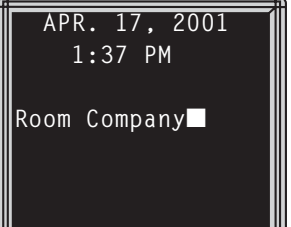
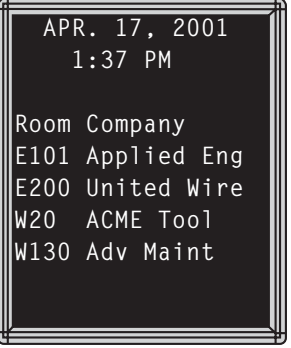
Before attempting the following, make sure you're familiar with the previous examples in the 6—Beginning text messaging section of this manual.

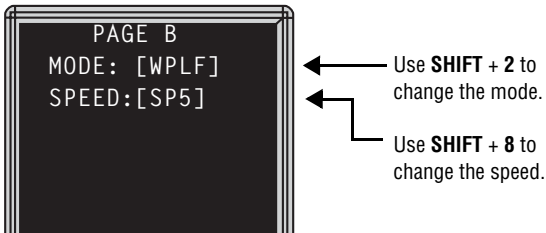
Example 6 — Displaying the time and date

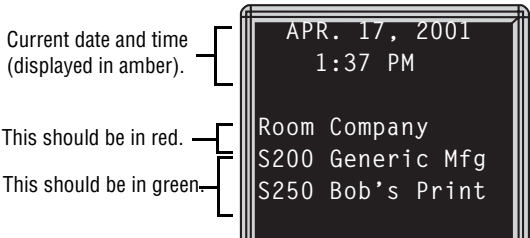
Step	When you do this...	You see this...
<p>In this example, we'll create a message that continuously displays the current time and date:</p> <div style="display: flex; justify-content: space-around;"> <div style="width: 45%;"> <p>Current date and time (displayed in amber). </p> <p>This will be displayed in red. </p> <p>This will be displayed in green. </p> </div> <div style="width: 45%; border: 1px solid black; padding: 5px;"> <p>APR. 17, 2001 1:37 PM</p> <p>Room Company E101 Applied Eng E200 United Wire W20 ACME Tool W130 Adv Maint</p> <p>PAGE A (The first message you'll enter.)</p> </div> </div> <div style="display: flex; justify-content: space-around; margin-top: 20px;"> <div style="width: 45%;"> <p>Current date and time (displayed in amber). </p> <p>This will be displayed in red. </p> <p>This will be displayed in green. </p> </div> <div style="width: 45%; border: 1px solid black; padding: 5px;"> <p>APR. 17, 2001 1:37 PM</p> <p>Room Company S200 Generic Mfg S250 Bob's Print</p> <p>PAGE B (The second message you'll enter.)</p> </div> </div>		
1	Delete all the messages currently stored in the sign. (See "Clearing a sign's memory" on page 32 or "Example 5 — Deleting messages" on page 46.)	
2	Press PROGRAM . (If <i>PAGE A</i> does not display, press A .)	
3	Change the mode to WIPE DOWN. Set the message transition speed to its fastest (SP5).	 <p>Use SHIFT + 2 to change the mode.</p> <p>Use SHIFT + 8 to change the speed.</p>

4	<p>Press ADV.</p> <p>Press COLOR until the cursor always blinks amber.</p> <p>Then press SPACE to move the cursor over two spaces.</p>	
Here's how to put the date in the message:		
5	<p>Hold down SHIFT and press 0.</p>	
6	<p>Press RETURN to start on a new line.</p> <p>Press COLOR until the cursor always blinks amber.</p> <p>Then press SPACE four times to move the cursor over.</p>	
Here's how to put the time in a message:		
7	<p>Hold down SHIFT and press 9.</p>	
Now enter the rest of the PAGE A message:		
8	<p>Press RETURN twice to skip down two lines.</p> <p>Press COLOR until the cursor always blinks red.</p> <p>Using CAPS when necessary, type Room, a space, and then Company.</p>	
9	<p>Press RETURN again to start on a new line.</p> <p>Press COLOR until the cursor always blinks green.</p> <p>Using CAPS when necessary, type E101, a space, and then Applied Eng.</p> <p>Repeat this process for the remaining lines of text.</p>	

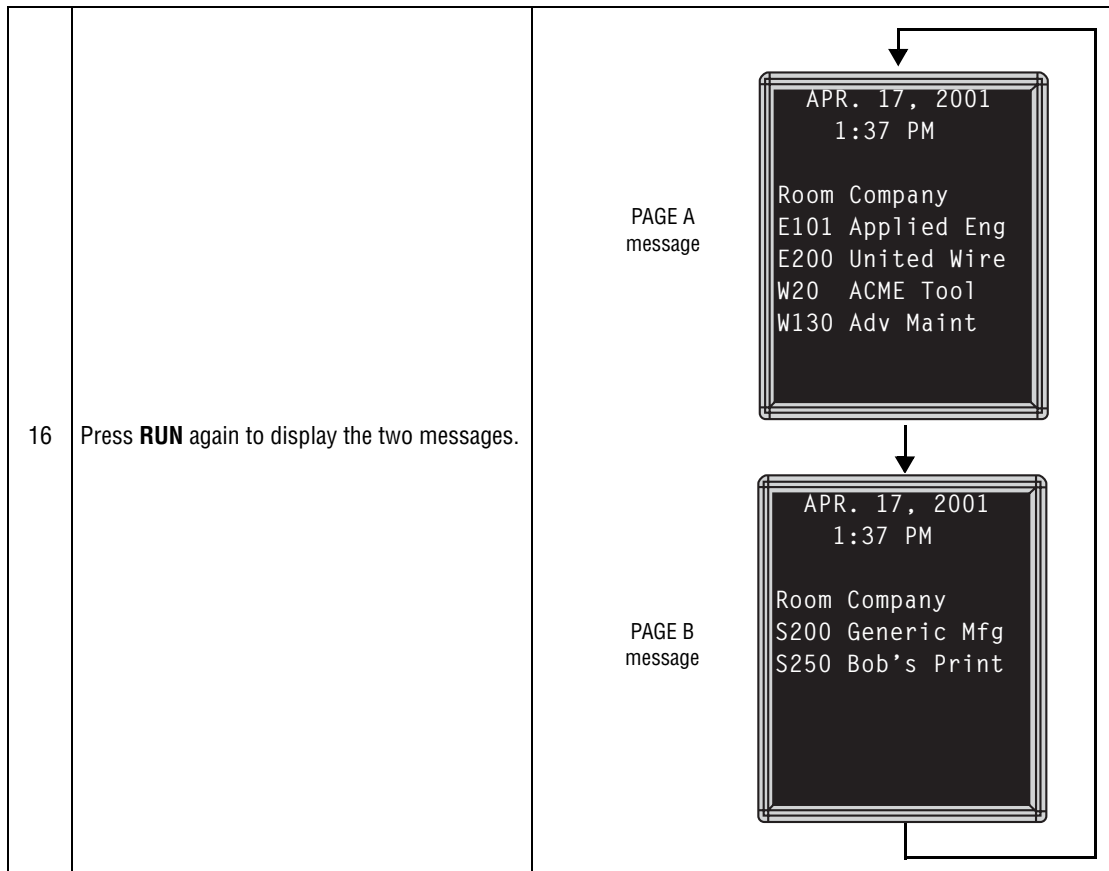

<p>10</p>	<p>Press PROGRAM.</p> <p>Press B to go to <i>PAGE B</i>.</p> <p>Change the mode to WIPE LEFT [WPLF].</p> <p>Change the speed to the fastest [SP5].</p>	
<p>11</p>	<p>Press ADV.</p>	
<p>12</p>	<p>Using what you've just learned, type in the <i>PAGE B</i> message as shown:</p>	
<p>13</p>	<p>Press RUN.</p>	
<p>14</p>	<p>Press SELECT until <i>RUN</i> appears.</p>	
<p>15</p>	<p>Type A and then B to set the order in which the two messages will appear.</p>	



Example 7 — Using the FLASH mode to highlight information

FLASH is a mode that you shouldn't overuse. However, it is very handy if you want to call attention to a single item, like a time or room number, on a page:

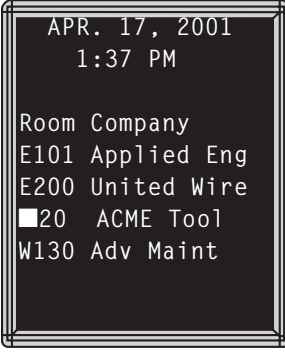
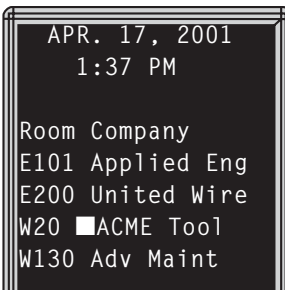
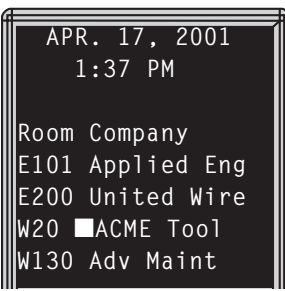
Step	When you do this...	You see this...
<p>In this example, we'll continue from the previous example:</p> <div style="display: flex; align-items: center;"> <div style="flex: 1;"> <p>To call attention to this room number, we'll make it flash on and off.</p> </div> <div style="flex: 1; border: 2px solid black; padding: 5px;"> <pre> APR. 17, 2001 1:37 PM Room Company E101 Applied Eng E200 United Wire W20 ACME Tool W130 Adv Maint </pre> </div> </div>		
1	<p>Press PROGRAM.</p> <p>(If <i>PAGE A</i> does not display, then press A.)</p>	<div style="border: 2px solid black; padding: 5px; text-align: center;"> <p>PAGE A</p> <p>MODE: [WPDN]</p> <p>SPEED:[SP5]</p> </div>
2	<p>Press ADV.</p>	<p>Blinking cursor</p> <div style="display: flex; align-items: center;"> <div style="flex: 1;"> <p>Since this continues where the last example left off, this is what should appear for PAGE A.</p> </div> <div style="flex: 1; border: 2px solid black; padding: 5px;"> <pre> ■ APR. 17, 2001 1:37 PM Room Company E101 Applied Eng E200 United Wire W20 ACME Tool W130 Adv Maint </pre> </div> </div>
3	<p>Press A.</p>	<div style="border: 2px solid black; padding: 5px;"> <pre> ■ APR. 17, 2001 1:37 PM Room Company E101 Applied Eng E200 United Wire W20 ACME Tool W130 Adv Maint </pre> </div>

<p>4</p>	<p>Hold down SHIFT and press C until the cursor is over the letter <i>W</i> in <i>W20</i>.</p>	<p>Move the cursor here.</p>  <p>APR. 17, 2001 1:37 PM Room Company E101 Applied Eng E200 United Wire ■20 ACME Tool W130 Adv Maint</p>
<p>5</p>	<p>Hold down SHIFT and press 4 for FLASH.</p>	<p>This entire line should now be flashing.</p>  <p>APR. 17, 2001 1:37 PM Room Company E101 Applied Eng E200 United Wire ■20 ACME Tool W130 Adv Maint</p>
<p>6</p>	<p>Move the cursor to in front of <i>ACME Tool</i>.</p>	<p>Hold down SHIFT and press F to move the cursor.</p>  <p>APR. 17, 2001 1:37 PM Room Company E101 Applied Eng E200 United Wire W20 ■ACME Tool W130 Adv Maint</p>
<p>7</p>	<p>Hold down SHIFT and press 4. This turns flashing off for the rest of the line.</p>	<p>Now the only text flashing should be the room number (<i>W20</i>).</p>  <p>APR. 17, 2001 1:37 PM Room Company E101 Applied Eng E200 United Wire W20 ■ACME Tool W130 Adv Maint</p>
<p>8</p>	<p>Press RUN to see the message.</p>	 <p>APR. 17, 2001 1:37 PM Room Company E101 Applied Eng E200 United Wire W20 ACME Tool W130 Adv Maint</p>

Example 8 — Using fonts and colors

Fonts are the way characters are displayed on a sign. In the world of printing and publishing, fonts are given names like Times or Helvetica, and qualities like serif or sans serif, font size (such as 12 point or 14 point), bold or italic, and so on.

This sign can display two types of fonts:

Upper *and* lowercase letters can be used with this font. —————> This is the first font.

Only uppercase letters can be used with this font. —————> THIS IS THE SECOND FONT.



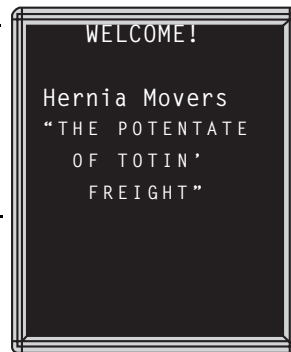



This is the message we'll create using both of the sign's fonts.







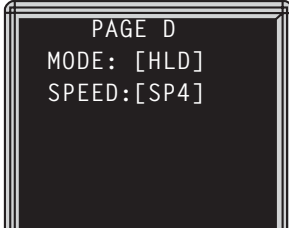

To change from one font to the other, press the **FONT** key.

The following examples demonstrate how to use fonts on a sign:

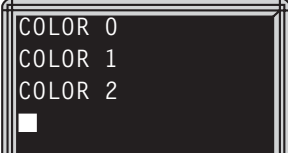
Step	When you do this...	You see this...
1	Press PROGRAM . (If <i>PAGE C</i> does not display, press C .) Using SHIFT + 5 , change the MODE to Hold.	
2	Press ADV .	
3	Type the following message:	

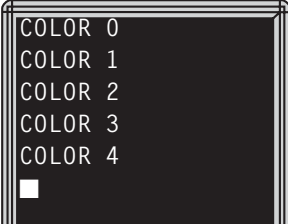
4	Move the cursor in front of the <i>The potentate</i> and then press FONT .	<p>Pressing FONT changes the entire line to a different font. →</p> <p>(Pressing FONT again would restore the original font.)</p> 
5	Move the cursor in front of the word <i>potentate</i> and press FONT . All text after the cursor should change to the other font.	<p>The FONT key can be used to change a whole line of text or just a single word.</p> 
6	Press FONT again to make the whole line the same font. Then position the cursor in front of the remaining lines and change the font of each line.	
7	Press RUN to see your message.	
Here's a demonstration of what colors can be used:		
8	<p>Press PROGRAM.</p> <p>(If <i>PAGE D</i> does not display, press D.)</p> <p>Using SHIFT + 5, change the MODE to Hold.</p>	
9	Press ADV .	

10	<p>Type COLOR 0</p> <p>Then press RETURN.</p>	<p>COLOR 0 should be red to start. When displayed in the message, it will cycle through several color schemes. →</p>	
11	<p>Press COLOR one time.</p> <p>Type COLOR 1.</p> <p>Then press RETURN.</p>	<p>COLOR 1 should be red. →</p>	
12	<p>Press COLOR two times.</p> <p>Type COLOR 2.</p> <p>Then press RETURN.</p>	<p>COLOR 2 should be green. →</p>	
13	<p>Press COLOR three times.</p> <p>Type COLOR 3.</p> <p>Then press RETURN.</p>	<p>COLOR 3 should be amber. →</p>	
14	<p>Press COLOR four times.</p> <p>Type COLOR 4.</p> <p>Then press RETURN.</p>	<p>COLOR 4 should be multi-colored with the same combination of colors for each character. →</p>	
15	<p>Press COLOR five times.</p> <p>Type COLOR 5.</p> <p>Then press RETURN.</p>	<p>COLOR 5 should be multi-colored with a different combination of colors for each character. →</p>	
16	<p>Press COLOR six times.</p> <p>Type COLOR 6.</p> <p>Then press RETURN.</p>	<p>Each character in COLOR 6 should be a different color. →</p>	
17	<p>Press RUN to see what all the colors look like in a running message.</p>		

Example 9 — International characters

International characters—like ü and é—can be included in messages.

NOTE: International characters cannot be used with the small font. If they are, a question mark (?) will appear in place of the letter.

The following table summarizes all the international characters that can be used:

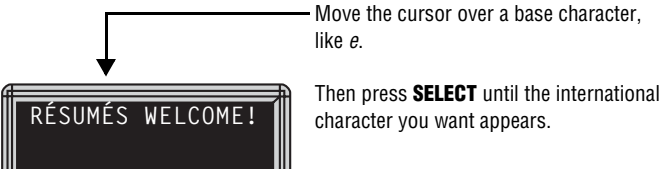
											
Base Characters	(Use the CAPS button on the remote control for uppercase versus lowercase letters.)										
	A	C	E	I	N	O	U	Y	?	!	\$
International Characters	â	Ç	é	ï	ñ	ô	ü	ÿ	¿	¡	¢
	ä	ç	ê	î	Ñ	ö	û	Ÿ	?	!	£
	ã	C	ë	ì	N	ò	U	y			¥
	À	c	è	l	n	Ó	ú				f
	Á		É	i		ó	U				\$
	æ		E			ø	u				
	Æ		e			O					
	á					o					
	à										
	A										
a											

8—Appendices

Appendix A—Quick Reference Card

Message control keys

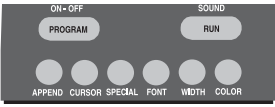

	
PROGRAM	To turn the sign on or off, hold down SHIFT and then press PROGRAM . To enter messages, set the date and time, clear memory, and so on. Press PROGRAM and then BACK until the setting you want to change is shown. Then press ADV to change that setting.
RUN	Press two times to exit program mode.
APPEND	Not used.
CURSOR	Not used.
SPECIAL	Not used.
FONT	Changes between a small or large font.
WIDTH	Not used.
COLOR	Changes the color of text.

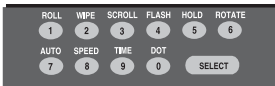
Display modes and special keys

	
ROLL	Not used.
WIPE	Hold down SHIFT and press 2 to use the WIPE mode in a message. Doing this more than once cycles through all the options for direction of the wipe.
SCROLL	Not used.
FLASH	Hold down SHIFT and press 4 to use the FLASH mode in a message.
HOLD	Hold down SHIFT and press 5 to use the HOLD mode in a message.
ROTATE	Not used.
AUTO	Hold down SHIFT and press 7 to use the AUTO mode in a message.
SPEED	Hold down SHIFT and press 8 to use the SPEED mode in a message. Doing this more than once cycles through all the options for speed. (SP1 = slowest, NHL = fastest)
TIME	Hold down SHIFT and press 9 to include the time in a message.
DATE	Hold down SPECIAL and press M to include the date in a message.

Appendix B—Sign diagnostic test

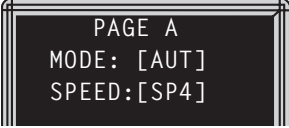

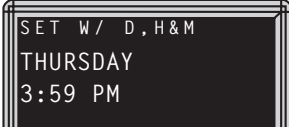
Your sign can perform a diagnostic test to determine if all the LEDs are working properly.

Step	When you do this...	You see this...
1	Press PROGRAM .	
2	Press BACK until <i>SET TIME AND DAY</i> appears.	
3	Press ADV .	
4	Type TEST .	The sign will go through a series a LED tests until PROGRAM is pressed again.
5	Press PROGRAM to exit the diagnostic test mode.	

Appendix C—Transferring a sign’s memory from one sign to another

You can transfer the messages from the memory of one sign to the memory of any another sign by completing the following steps.

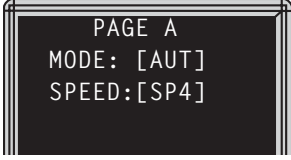
NOTE: To complete the transfer of memory from one sign to other signs, all signs must be connected together. For information on connecting signs, see “Connecting signs to a computer” on page 23. For detailed information, see the **Networking Alpha Signs** manual, PN 9700-0112.

Step	When you do this...	You see this...
1	Press PROGRAM .	
2	Press SPECIAL .	
3	Press D .	
4	The sending sign transmits all messages to the receiving sign and then resumes displaying messages as programmed.	

With the aluminum Director, you can also use the RS485 echo feature to transfer a sign’s memory from one sign to another. Please refer to Appendix H—RS232 in and echo out RS485 (aluminum Director) on page 56.

Appendix D—Using the IR Message Loader

The IR (InfraRed) Message Loader is a hand-held device used to transfer messages from one sign to another, or from a computer to a sign, using messaging software.

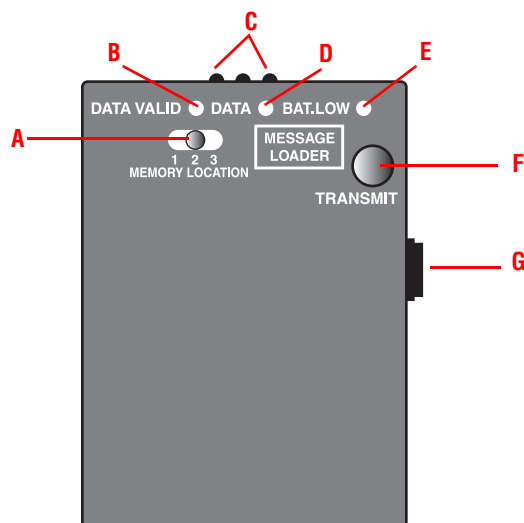

Item	Name	Description
A	MEMORY LOCATION switch	Allows you to select one of the three 10,000-byte memory partitions.
B	DATA VALID indicator	Indicates valid data in the memory location currently selected.
C	Infrared transmitters	Used to transmit messages stored in MEMORY LOCATIONS to signs.
D	DATA indicator	When lit, indicates data is being sent or received via the serial port or the infrared transmitters.
E	BAT. LOW indicator	When lit, indicates that the battery should be replaced.
F	TRANSMIT button	When transferring a message from a PC into the IR Message Loader, pressing this button stores the message in the selected MEMORY LOCATION. When transferring a message from the IR Message Loader into a sign, pressing this button sends the message in the currently selected MESSAGE LOCATION to a sign.
G	Serial port	Connects to the Director sign.

Transferring messages from a PC to the IR Message Loader

1. Connect the IR Message Loader to a PC running Alpha Messaging Software Director Edition. See the **IR Message Loader Instructions** manual, PN 9707-1003.
2. In the Alpha Messaging Software Director Edition, create a test message.
3. In the Configuration Utility of the Alpha Messaging Software Director Edition, verify the correct COM port is selected.
4. On the IR Message Loader, set the **MEMORY LOCATION** switch to the location (1, 2, or 3) to which the messages will download.
5. On the IR Message Loader, press and then release the **TRANSMIT** button.
6. Wait at least 2 seconds. Then use Alpha Messaging Software Director Edition to send your message to the IR Message Loader.
7. The data indicator on the IR Message Loader should light up while a message downloads. When the DATA VALID light indicator turns on, the message download is complete.

If the message download fails, repeat from step 4.

Transferring messages from the IR Message Loader to a sign

1. Connect the IR Message Loader to a Director sign.
2. On the IR Message Loader, set the **MEMORY LOCATION** switch to the location (1, 2, or 3) that you used in “Transferring messages from a PC to the IR Message Loader”.
3. Press and hold the **TRANSMIT** button on the IR Message Loader. The data indicator should light up.

When the data indicator turns off, the messages have been transferred to the sign.

Appendix E—Updating the firmware (wood Director)

Updating the sign's firmware (or EPROM)

From time to time it may be necessary to update the sign's internal firmware by replacing an EPROM inside the sign. To do this, follow these steps:

1. Remove power from the sign.

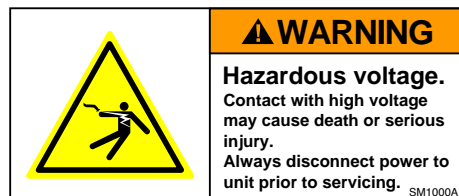

2. Replace the sign's internal EPROM according to this diagram:

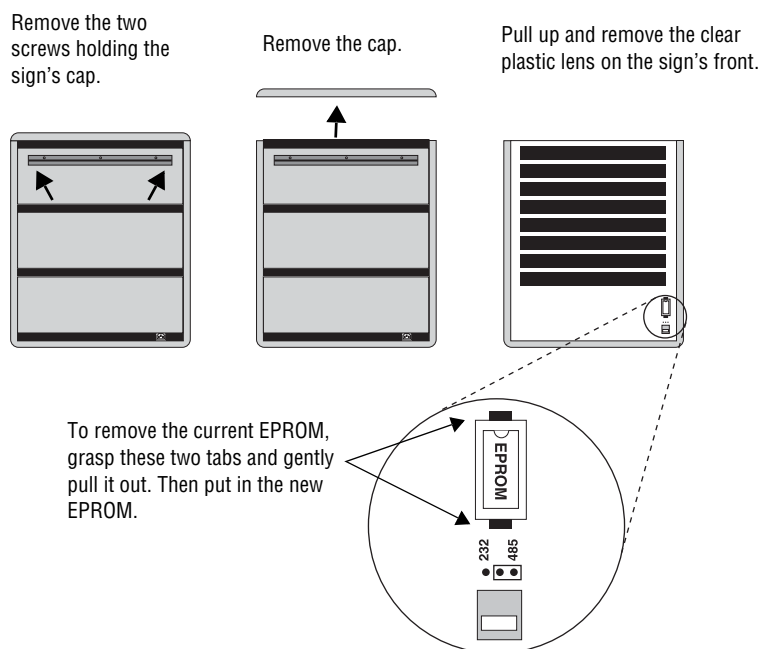

3. Re-assemble the sign.

Appendix F—DIP switch access (aluminum Director)

1. Remove power from the sign.

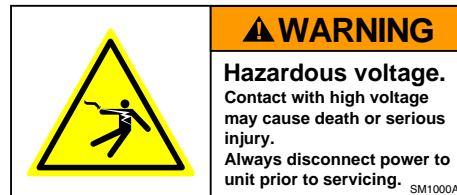

2. If the sign is mounted, remove it and place it on a flat surface.
3. Remove the access cap, located above the RS232/RS485 ports on the back of the sign, by gently pulling it out.

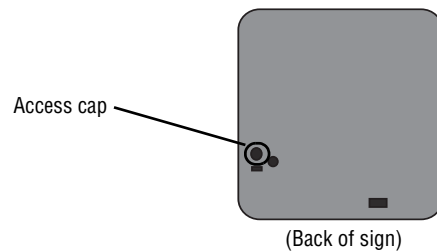

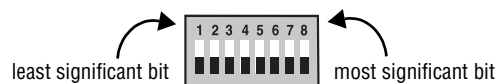

4. Use a screwdriver to move each DIP switch. See "Appendix G—DIP switch settings (aluminum Director)" on page 64 for settings.



5. Reattach the access cap after making any changes.

Appendix G—DIP switch settings (aluminum Director)

Setting in Decimal	DIP switch settings (1 = ON, 0 = OFF)								Setting in Decimal	DIP switch settings (1 = ON, 0 = OFF)							
	1	2	3	4	5	6	7	8		1	2	3	4	5	6	7	8
00	0	0	0	0	0	0	0	0	51	0	0	1	1	0	0	1	1
01	0	0	0	0	0	0	0	1	52	0	0	1	1	0	1	0	0
02	0	0	0	0	0	0	1	0	53	0	0	1	1	0	1	0	1
03	0	0	0	0	0	0	1	1	54	0	0	1	1	0	1	1	0
04	0	0	0	0	0	1	0	0	55	0	0	1	1	0	1	1	1
05	0	0	0	0	0	1	0	1	56	0	0	1	1	1	0	0	0
06	0	0	0	0	0	1	1	0	57	0	0	1	1	1	0	0	1
07	0	0	0	0	0	1	1	1	58	0	0	1	1	1	0	1	0
08	0	0	0	0	1	0	0	0	59	0	0	1	1	1	0	1	1
09	0	0	0	0	1	0	0	1	60	0	0	1	1	1	1	0	0
10	0	0	0	0	1	0	1	0	61	0	0	1	1	1	1	0	1
11	0	0	0	0	1	0	1	1	62	0	0	1	1	1	1	1	0
12	0	0	0	0	1	1	0	0	63	0	0	1	1	1	1	1	1
13	0	0	0	0	1	1	0	1	64	0	1	0	0	0	0	0	0
14	0	0	0	0	1	1	1	0	65	0	1	0	0	0	0	0	1
15	0	0	0	0	1	1	1	1	66	0	1	0	0	0	0	1	0
16	0	0	0	1	0	0	0	0	67	0	1	0	0	0	0	1	1
17	0	0	0	1	0	0	0	1	68	0	1	0	0	0	1	0	0
18	0	0	0	1	0	0	1	0	69	0	1	0	0	0	1	0	1
19	0	0	0	1	0	0	1	1	70	0	1	0	0	0	1	1	0
20	0	0	0	1	0	1	0	0	71	0	1	0	0	0	1	1	1
21	0	0	0	1	0	1	0	1	72	0	1	0	0	1	0	0	0
22	0	0	0	1	0	1	1	0	73	0	1	0	0	1	0	0	1
23	0	0	0	1	0	1	1	1	74	0	1	0	0	1	0	1	0
24	0	0	0	1	1	0	0	0	75	0	1	0	0	1	0	1	1
25	0	0	0	1	1	0	0	1	76	0	1	0	0	1	1	0	0
26	0	0	0	1	1	0	1	0	77	0	1	0	0	1	1	0	1
27	0	0	0	1	1	0	1	1	78	0	1	0	0	1	1	1	0
28	0	0	0	1	1	1	0	0	79	0	1	0	0	1	1	1	1
29	0	0	0	1	1	1	0	1	80	0	1	0	1	0	0	0	0
30	0	0	0	1	1	1	1	0	81	0	1	0	1	0	0	0	1
31	0	0	0	1	1	1	1	1	82	0	1	0	1	0	0	1	0
32	0	0	1	0	0	0	0	0	83	0	1	0	1	0	0	1	1
33	0	0	1	0	0	0	0	1	84	0	1	0	1	0	1	0	0
34	0	0	1	0	0	0	1	0	85	0	1	0	1	0	1	0	1
35	0	0	1	0	0	0	1	1	86	0	1	0	1	0	1	1	0
36	0	0	1	0	0	1	0	0	87	0	1	0	1	0	1	1	1
37	0	0	1	0	0	1	0	1	88	0	1	0	1	1	0	0	0
38	0	0	1	0	0	1	1	0	89	0	1	0	1	1	0	0	1
39	0	0	1	0	0	1	1	1	90	0	1	0	1	1	0	1	0
40	0	0	1	0	1	0	0	0	91	0	1	0	1	1	0	1	1
41	0	0	1	0	1	0	0	1	92	0	1	0	1	1	1	0	0
42	0	0	1	0	1	0	1	0	93	0	1	0	1	1	1	0	1
43	0	0	1	0	1	0	1	1	94	0	1	0	1	1	1	1	0
44	0	0	1	0	1	1	0	0	95	0	1	0	1	1	1	1	1
45	0	0	1	0	1	1	0	1	96	0	1	1	0	0	0	0	0
46	0	0	1	0	1	1	1	0	97	0	1	1	0	0	0	0	1
47	0	0	1	0	1	1	1	1	98	0	1	1	0	0	0	1	0
48	0	0	1	1	0	0	0	0	99	0	1	1	0	0	0	1	1
49	0	0	1	1	0	0	0	1	100	0	1	1	0	0	1	0	0
50	0	0	1	1	0	0	1	0									

Appendix H—RS232 in and echo out RS485 (aluminum Director)

When RS485 echo is enabled, incoming data (from either RS232 or Ethernet) is echoed (sent out the RS485 jack) to other networked signs. To enable RS485 echo, do the following:

1. Remove power from the sign.

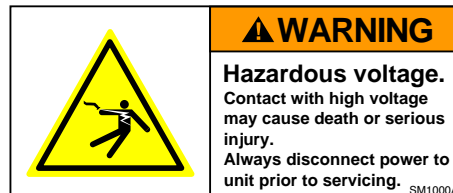

2. If the sign is mounted, remove it and place it on a flat surface.
3. Remove the hole plug, located to the right of the access cap and the RS232/485 ports on the back of the sign, by gently pulling it out.

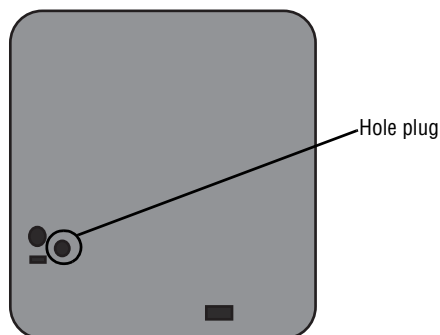

4. Remove the shorting jumper from J14.

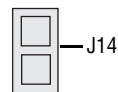

5. Reattach the hole plug to the back of the sign. When RS232 is sent into a sign, RS485 will automatically be sent out.

RS485 echo is useful when connecting multiple signs together because it can eliminate the need to use a Converter Box:

